

PRIMETEST 350

The most advanced PAT tester in the world

Operating Instructions



Bracken Hill
South West Industrial Estate
Peterlee
Co Durham
SR8 2SW
ENGLAND
Tel: +44(0)191 5863511

www.seaward.co.uk
sales@seaward.co.uk
service@seaward.co.uk

Part Number 356A558 Revision 1
November 2007
© 2007 Seaward Electronic Ltd

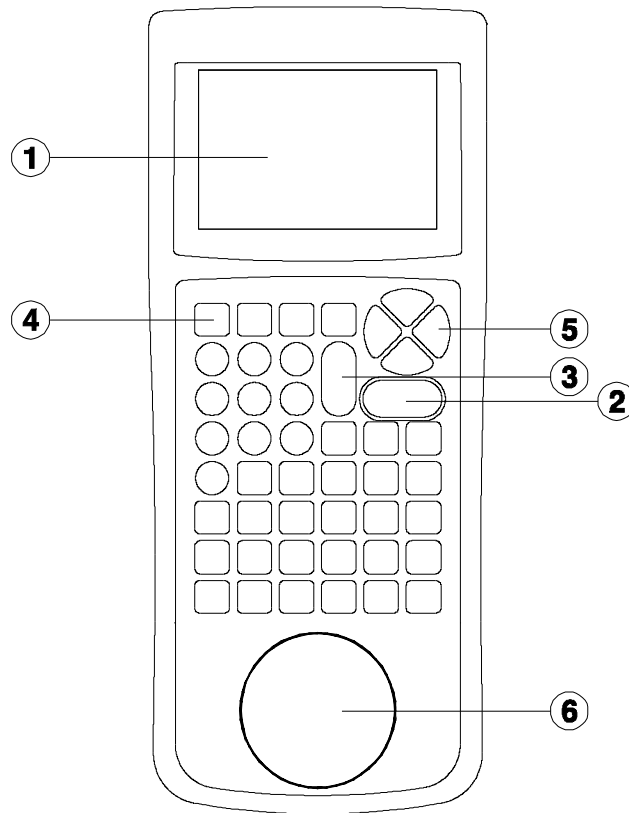

Figure 1 PrimeTest 350 Front View

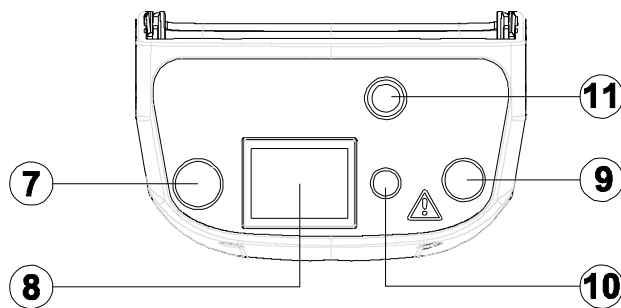

Figure 2 PrimeTest 350 End View

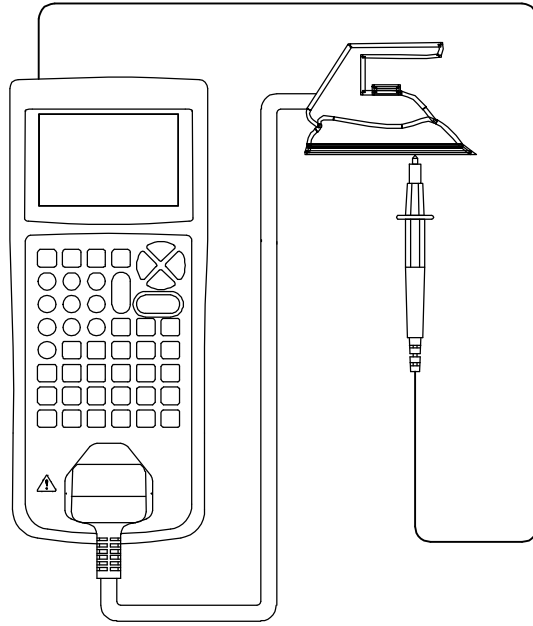

Figure 3 Earth Continuity Measurement

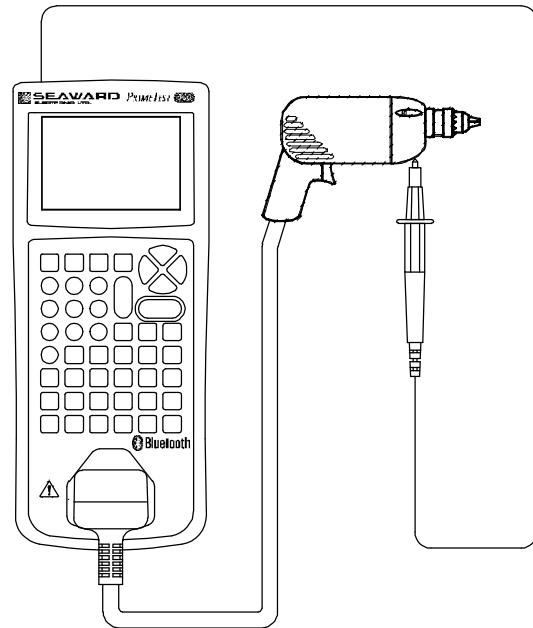

Figure 4 Insulation Measurement (Class II)

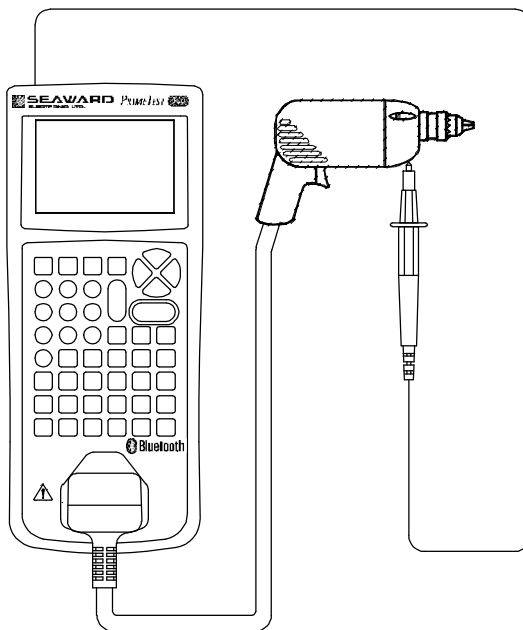

Figure 5 Substitute Leakage Measurement (Class II)

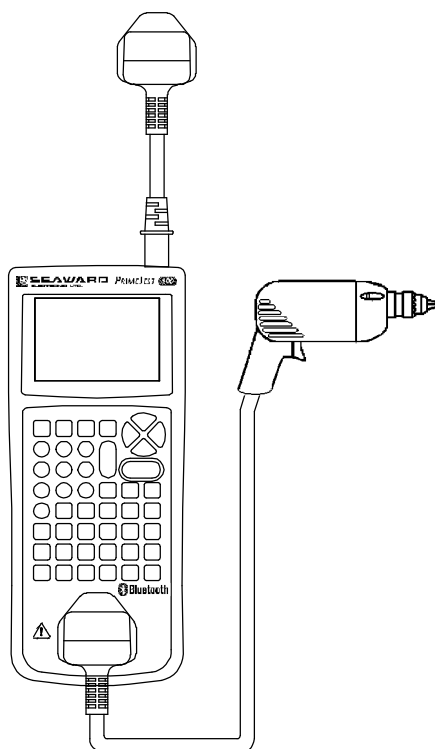

Figure 6 Protective Earth (PE) Conductor Current Measurement

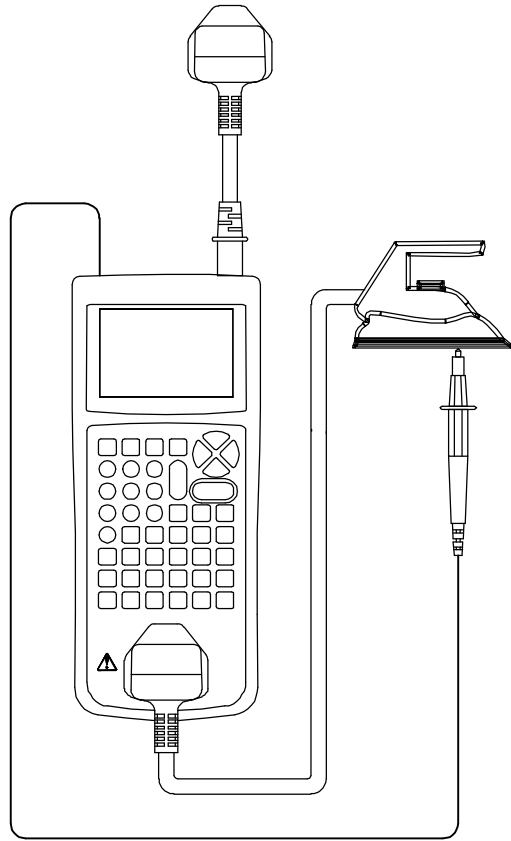

Figure 7 Touch Leakage Measurement

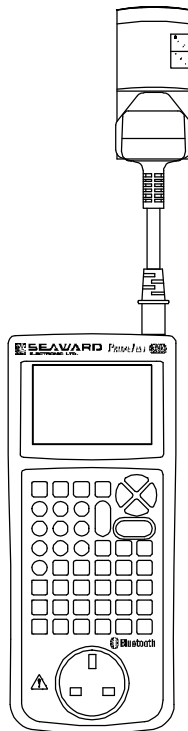

Figure 8 RCD and Earth Loop Test

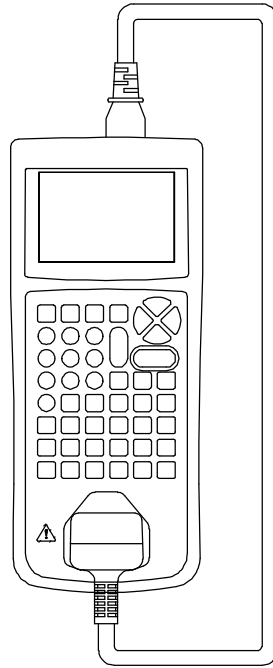

Figure 9 IEC Lead Test

Limited Warranty & Limitation of Liability

SEAWARD Electronic Limited guarantees this product to be free from defects in material and workmanship under normal use and service for a period of 1 year. The period of warranty will be effective at the day of delivery.

(c) Copyright 2007

All rights reserved. Nothing from this edition may be multiplied, or made public in any form or manner, either electronically, mechanically, by photocopying, recording, or in any manner, without prior written consent from SEAWARD Electronic Limited. This also applies to accompanying drawings and diagrams.

Due to a policy of continuous development SEAWARD Electronic Limited reserves the right to alter the equipment specification and description outlined in this publication without prior notice and no part of this publication shall be deemed to be part of any contract for the equipment unless specifically referred to as an inclusion within such contract.

Disposal of old product

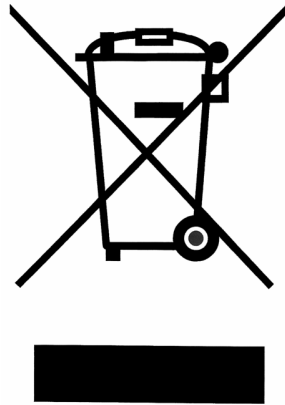

This product has been designed and manufactured with high quality materials and components that can be recycled and reused.

When this symbol is attached to a product it means the product is covered by the European Directive 2002/96/EC.

Please familiarise yourself with the appropriate local separate collection system for electrical and electronic products.

Please dispose of this product according to local regulations. Do not dispose of this product along with normal waste material. The correct disposal of this product will help prevent potential negative consequences for the environment and human health.

Table of Contents

1	User Notes	15
2	Safety Notes	16
3	Accessories	18
3.1	Standard Accessories	18
3.2	Optional Accessories	18
4	Unit Description	19
5	Getting Started	20
5.1	Charging New Batteries	20
5.2	Power On	20
5.3	How to Navigate Menus	20
5.4	Battery Health Check	21
5.5	Connecting to Accessories	21
6	Data Transfer	22
6.1	Download to PC	22
6.2	Upload from PC	25
6.3	Send/Receive Config Data	25
6.3.1	Send Config Data	25
6.3.2	Receive Config Data	27
6.4	Load Test'n'Tag Logo	28
7	View Saved Data	29
7.1	Search	29
7.2	Options	30
7.3	Viewing Test Details	30
8	Memory Options	31
9	Configuration	32
9.1	Edit Test Sequences	32
9.1.1	Edit Sequence	33
9.1.2	Copy Sequence	33
9.1.3	Delete Sequence	34
9.1.4	Creating a New Sequence	34
9.1.5	User Tests	36
9.1.6	Print Sequence	39
9.2	Set Date/Time	40
9.3	Bluetooth Favourites	40
9.4	Restore Factory Settings	40
9.5	Restore Factory Sequences	40
9.6	Verify Calibration	40
10	User Options	41
10.1	Test Options	41
10.1.1	Asset ID	42
10.1.2	Start Increment	42
10.1.3	On Test Failure	42
10.1.4	After Test	42
10.1.5	Sub Lkg Factor	43

10.1.6	Earth Result.....	44
10.1.7	Comments	44
10.1.8	Comments Line	44
10.2	Preferences	45
10.2.1	Display Time.....	45
10.2.2	Set Contrast	45
10.2.3	Auto Off Time (mins).....	45
10.2.4	Data Entry.....	45
10.2.5	Backlight Mode.....	46
10.2.6	Type of User	46
10.2.7	Tones	46
10.3	Change User	46
10.4	Change Password.....	49
11	Manual Test Functions.....	51
11.1	Earth Continuity.....	51
11.2	Insulation Resistance.....	52
11.3	Substitute Leakage	53
11.4	Protective Earth (PE) Conductor Current..	54
11.5	Touch Current	55
11.6	Earth Loop Resistance	57
11.7	RCD Trip Time	57
11.8	IEC Lead.....	58
12	Bluetooth Functions.....	60
12.1	Bluetooth USB Adapter	60
12.2	Bluetooth Favourites	61
12.3	Bluetooth Connection to a Printer.....	66
12.4	Bluetooth Connection to a PC.....	68
13	Automatic Test Mode	69
13.1	Entering an Asset ID	69
13.2	Entering Site Information	71
13.2.1	Seaward Quick Text	71
13.2.2	Selecting a Site using Quick Text.....	72
13.3	Entering Location Information	76
13.3.1	Selecting Location using Quick Text	76
13.3.2	Adding a new Location	77
13.4	Selecting a Test Sequence	78
13.5	Frequency of inspection	79
13.6	Running the test sequence.....	80
13.7	Options.....	88
13.7.1	View Results.....	89
13.7.2	Information.....	89
13.7.3	Print Label	90
13.7.4	Print Result	90
13.7.5	Write RFID Tag	90
14	Printer Driver Specifications.....	91
14.1.1	Test'n'Tag Elite	91

14.1.2	Citizen CMP-10BT	93
14.1.3	Test 'n' Tag	94
14.1.4	Generic ASCII	96
15	Electrical Specifications	97
15.1	Earth Continuity	97
15.2	Insulation Resistance	97
15.3	Substitute Leakage	97
15.4	Protective Earth Conductor Current	98
15.5	Touch Current	98
15.6	Voltage/Frequency Measurement	98
15.7	Load Measurement	99
15.8	Earth Loop Resistance	99
15.9	RCD Trip Time	99
15.10	IEC Lead Test	99
16	Environmental Conditions	100
17	Maintenance	101
17.1	Preparing to work on the PrimeTest 350	101
17.2	Securing the PrimeTest 350	101
17.3	Cleaning	102
17.4	Battery Charging	102
17.5	Battery Replacement	103
17.6	Replacing All Fuses	104
17.7	Service and Calibration	106
	Spare Parts	107
18	Useful Information	108

DECLARATION OF CONFORMITY

As the manufacturer of the apparatus listed, declare under our sole responsibility that the product:

PrimeTest 350

To which this declaration relates are in conformity with the relevant clauses of the following standard:

BS EN 61010-1:2001

Safety requirements for electrical equipment for measurement, control, and laboratory use – Part 1: General requirements.

BS EN 61326:1998

Electrical equipment for measurement, control and laboratory user-EMC Requirements

Performance: The instrument operates within specification when used under the conditions in the above standards EMC and Safety Standards.

The product identified above conforms to the requirements of Council Directive 89/336/EEC and 73/23 EEC.

Seaward Electronic Ltd is registered under BS EN ISO9001:2000 Certificate No: Q05356.

Introduction

The PrimeTest 350 is a hand held, battery powered, multifunction test instrument capable of performing a comprehensive range of safety tests, including:

- Earth Continuity
- Insulation Resistance
- Substitute Leakage
- Power socket wiring check
- Protective Earth (PE) Conductor Current
- Touch Current
- RCD Trip Time
- Earth Loop Resistance
- IEC Cord Test
- User defined tests.

The unique User Test facility in the PrimeTest 350 allows tests to be carried out on any electrical or non-electrical appliance.

In addition to the standard electrical safety tests, test records for items such as Fire Extinguishers, Microwave Ovens, Emergency Lighting can now be created and stored. Test records can be downloaded to PATGuard for complete traceability.

The PrimeTest 350 is battery powered to allow greater flexibility and portability. It is shipped complete with NiMH rechargeable batteries and Seaward PT-01 charger

The PrimeTest 350 uses the latest in wireless technology to communicate with the range of available accessories.

1 User Notes

These operating instructions are intended for the use of adequately trained personnel.

The following symbols are used in these operating instructions and on the PrimeTest 350.



Warning of electrical danger!

Indicates instructions must be followed to avoid danger to persons.



Caution, follow the documentation! This symbol indicates that the operating instructions must be adhered to in order to avoid danger.

Note: *The PrimeTest 350 is equipped with context sensitive help, providing useful advice and guidance on the safe use of this product. When help is available a HELP icon will appear above the function key F1.*

Note: *Data may be lost or altered in virtually any electronic memory under certain circumstances. Therefore Seaward Electronic assumes no responsibility for financial losses or claims due to data lost or otherwise rendered unusable whether as a result of abuse, improper use, defects, disregard of operating instructions or procedures, or any allied causes.*

2 Safety Notes

This PrimeTest 350 has been built and tested in accordance with:

BS EN 61010-1: 2001.

BS EN 61557 part 1, 2, 4 and 10.

To ensure safe operation of the unit, all notes and warnings in these instructions must be observed at all times.



This instrument may be used on electrical circuits which comply to over voltage category II.



Attention! During Insulation Resistance tests high voltage levels occur within the PrimeTest 350.



The tester and all associated cables and leads must be checked for signs of damage before equipment is operated.



Never attempt to charge non-rechargeable cells in the PrimeTest 350.



Always check that the correct NiMH batteries are fitted before connecting the charger.



Only use the Seaward PT- 01 charger to charge the batteries in the PrimeTest 350.

Where safe operation of the tester is no longer possible it should be immediately shut down and secured to prevent accidental operation.

It must be assumed that safe operation is no longer possible:

- if the instrument or leads show visible signs of damage or
- the instrument does not function or
- after long periods of storage under adverse environmental conditions.



- Do not operate the PrimeTest 350 in an explosive gas or dust environment.
- Do not touch the bare tip of the measuring lead.



The PrimeTest 350 has been designed to make measurements in a dry environment. It must not be used for making measurements on electric circuits with nominal voltage greater than 300 V AC/DC.

3 Accessories

3.1 Standard Accessories

The PrimeTest 350 is supplied with the following items:

- 3.1.1 1 off PrimeTest 350 unit
- 3.1.2 1 off professional carry case
- 3.1.3 1 off Seaward mains cord
- 3.1.4 1 off 1.2m test lead black
- 3.1.5 1 off alligator clip, black
- 3.1.6 6 off Nickel Metal Hydride cells (size LR6)
- 3.1.7 1 off Seaward PT-01 Battery charger
- 3.1.8 1 off IEC Test Lead
- 3.1.9 1 off Operating Instruction Manual
- 3.1.10 1 off Utilities CD-ROM
- 3.1.11 1 off RS-232 to PC adapter cable
- 3.1.12 1 off RS232-USB Adaptor
- 3.1.13 1 off 110V/230V Adaptor

3.2 Optional Accessories

- 3.2.1 Bluetooth Label Printer
- 3.2.2 Bluetooth Barcode Scanner
- 3.2.3 Bluetooth RFID Wand
- 3.2.4 Bluetooth adaptor for Test'n'Tag Printer
- 3.2.5 USB Bluetooth Adapter (with CD-ROM and manual)

It should be noted that the following parts of the PrimeTest 350 are user serviceable and must be replaced with appropriate parts as detailed below:

Fuse, 250V 16A 5x20mm Type T 27B114



Do not open unit, no other serviceable parts.

4 Unit Description

Refer to fig. 1 and fig. 2.

The PrimeTest 350 is a hand held, multi function, instrument designed to perform electrical safety tests on Class I and Class II equipment as well as performing installation checks.

Identifying parts of the unit

- 1 LCD Display
- 2 **ON/START** key. Used to switch the PrimeTest 350 on or to start manual and automatic tests
- 3 **OFF/STOP** key. Used to switch the PrimeTest 350 off or to stop manual and automatic tests
- 4 F1 – F4 Function keys. The purpose of these keys changes depending upon the mode of the instrument. The lower part of the LCD display describes these functions.
- 5 Arrow keys. These keys are used to navigate the menu system and set up the instrument.
- 6 EUT socket. Fit the mains plug of the Equipment Under Test into this socket.
- 7 Mains Inlet. Fit the Seaward mains cable into this socket. Required during powered tests.
- 8 IEC Inlet. Used only for testing IEC mains leads. This is not a mains inlet!
- 9 Probe socket. Plug the black lead into this socket.
- 10 External battery charger input.
- 11 RS-232 connector.

5 Getting Started

5.1 Charging New Batteries

Before using the PrimeTest 350 for the first time the rechargeable cells provided will need to be inserted into the unit and then charged. See section 17.4.

5.2 Power On

Switch on the PrimeTest 350 by pressing, and holding, the green **ON/START** key. After 2-3 seconds the unit will beep and the display will show a 'boot up screen'. This screen will show the firmware version installed.

The first time the PrimeTest 350 is powered up the User will be automatically set to **Admin**. The Admin user gives full access to all the menus and functionality of the unit.

For further information about changing User and Password see **section 10.3 – Change User & section 10.4 – Change Password**.

The PrimeTest 350 will now be ready to use in Manual mode. Refer to section 11 for more details.

5.3 How to Navigate Menus

Most of the functions within the PrimeTest 350 can be accessed from the menus.

Press **Menu** (F4) to select the main menu. Use the up/down arrow keys to highlight the desired function or sub-menu. Press either **OK** (F4) or the right arrow key to select.

Note: *An alternative method of navigating the menus is to use the Fast Key option. Press Menu (F4) and note that each menu option has a letter underlined. By pressing that letter key the menu option will be selected.*

The right arrow can also be used to select a menu option.

5.4 Battery Health Check

While the PrimeTest 350 is powered on there are periodic checks of the batteries. As the batteries discharge the symbols below will appear on the right side of the LCD. If there is no battery symbol on the display the batteries are good/fully charged.



Batteries still good



Batteries still good



This symbol will flash indicating the batteries are ready for re-charge. Note:-Tests performed with the batteries in this state are still valid.



This symbol will flash for 2-4 seconds accompanied by a beeping sound. The unit will then power itself off. Batteries must be re-charged.

5.5 Connecting to Accessories

Before using the PrimeTest 350 to perform tests it is necessary to ensure the unit is ready to work with the various accessories that the user has. Instructions for this can be found in **section 12 - Bluetooth Functions**.

6 Data Transfer

Data transfer is used to transfer records and configuration data to and from a PC. It is also used to load a logo in bitmap format for use with the Seaward Test 'n' Tag print system.

The Data Transfer functions are accessed by pressing **Menu** (F4), selecting **Data Transfer** using the arrow keys and pressing **OK** (F4).

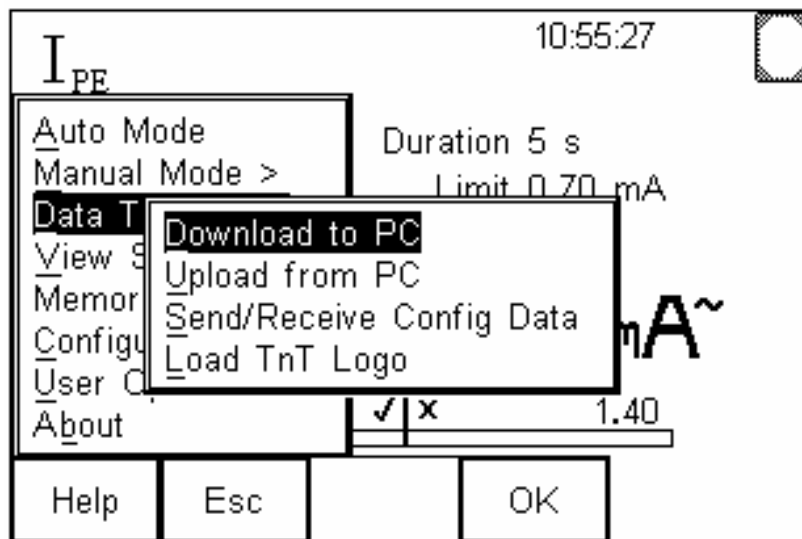

6.1 Download to PC

This feature is used to download records to a PC. Select Download to PC and press **OK** (F4) to accept.

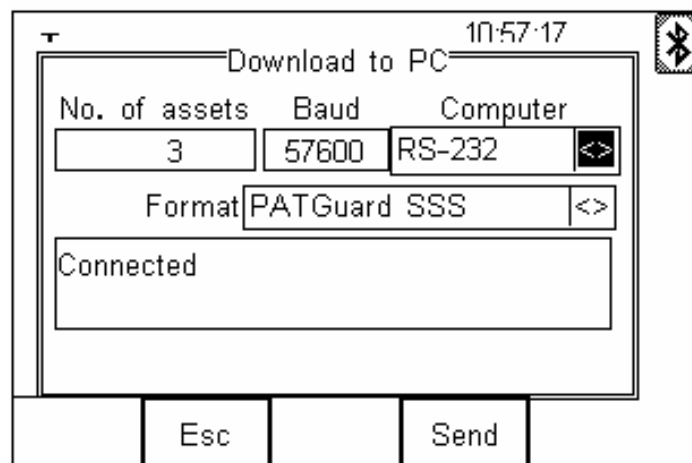

Use the left and right arrow keys to select Bluetooth

favourite computer or RS-232. If using RS-232 make sure the PrimeTest 350 is connected to the correct serial port on your computer.

Note: ***If there is no Favourite Computer configured then only the RS-232 option will be available as shown below.***

The PrimeTest 350 will attempt to make a Bluetooth connection with the Computer that has been configured as **Bluetooth Favourite**.

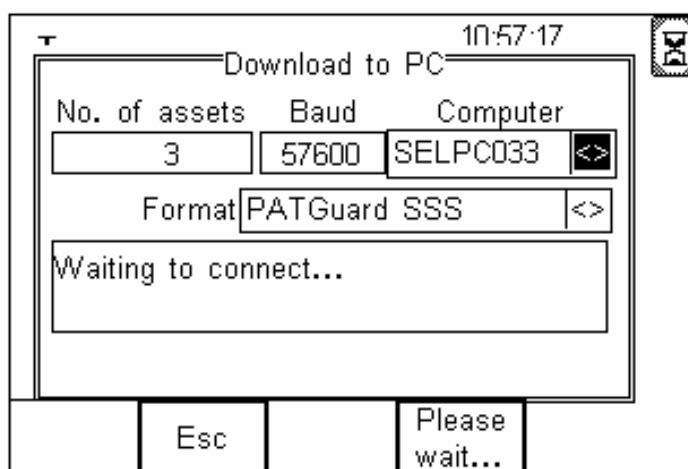

Initially, the Bluetooth status icon will display the egg timer for a few seconds, as shown above, while the connection is established. When the connection is established and ready to communicate the Bluetooth status icon will change to show the Bluetooth icon as shown below.

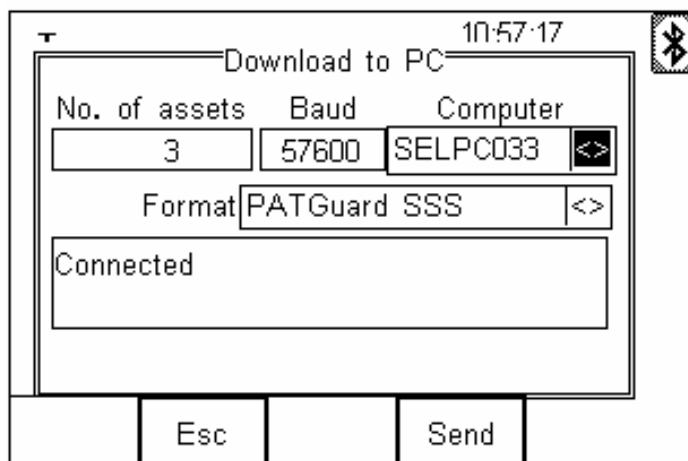

The PrimeTest 350 is now ready to transfer data. **No. of assets** shows the number of records that will be downloaded. **Format** shows the data format that will be used. Use the arrow keys to change to the correct format for your application.

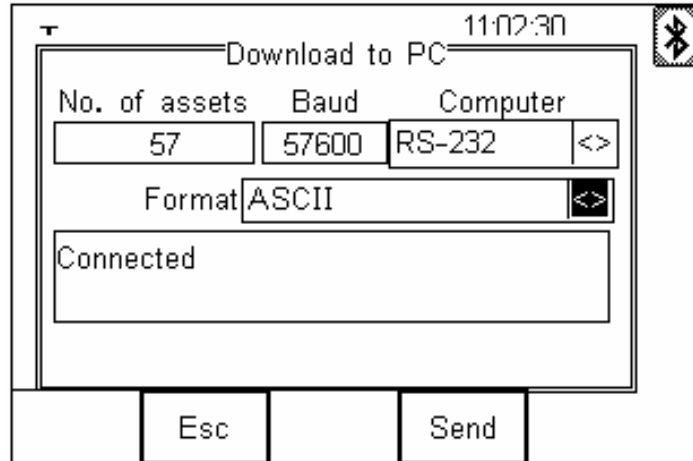

Ensure that the PC application is ready to receive data then press **Send** (F4).

A progress bar, as shown below, will now follow the data transfer until download is complete.

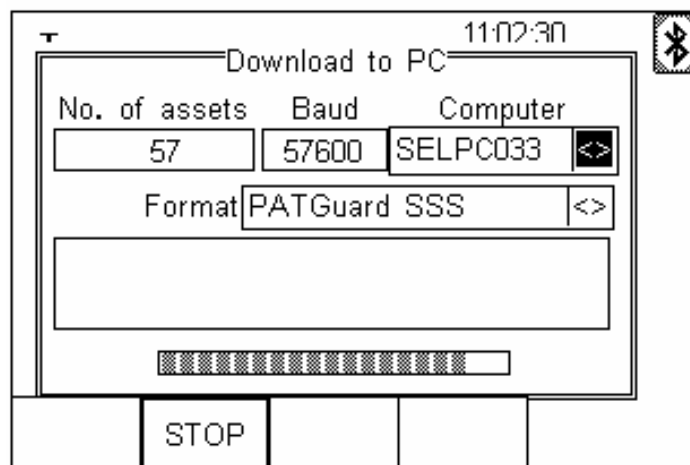

6.2 Upload from PC

Select the **Upload from PC option** from the **Data Transfer** menu. The PrimeTest 350 will now attempt to establish a Bluetooth connection to the PC as previously described in **6.1 Download to PC**. The PrimeTest 350 is now ready to receive upload data from a PC.

6.3 Send/Receive Config Data

This feature can be used to transfer **Site, Location, User and Comments** lists to/from a PC. It can be used to configure individual PrimeTest 350 units with identical **Site, Location, User and Comments** lists.

6.3.1 Send Config Data

To **Send** configuration data from a PC, press **Menu** (F4), select **Data Transfer** using the arrow keys, select **Send/Receive Config Data** and press **OK** (F4).

The PrimeTest 350 will now attempt to connect to the **Bluetooth Favourite** PC. When a connection has been established the display will be as shown below.

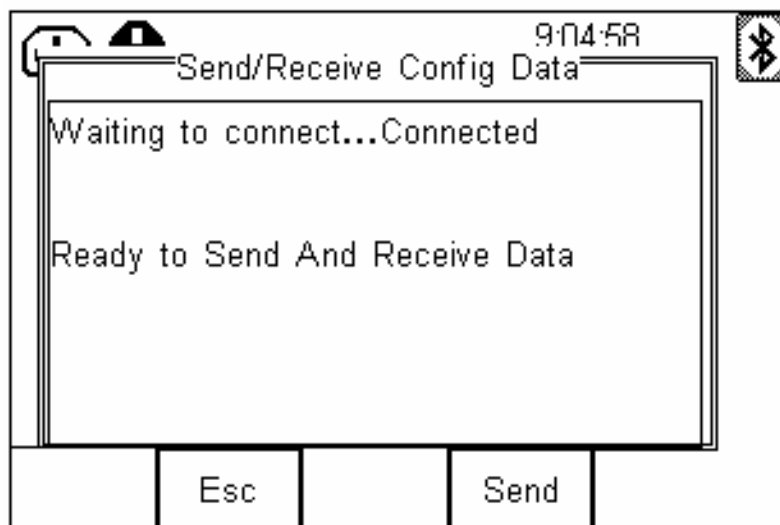

Open the **DataTransfer.exe** application on your PC and check that the Com Port for the Bluetooth serial

port (provided by the Bluetooth USB adapter) is selected. The baud rate will default to the correct value of 57600.

The Send (F4) key will transfer the Site, Location, User and Comments list from the PrimeTest 350 to the PC as text which will appear in the **DataTransfer.exe** screen.

Note: *The file transfer can be made using any suitable PC application such as Seaward DataTransfer or Hyperterminal capable of sending and receiving a text file.*

Data is transferred to the PrimeTest 350 using the format shown below:

[SiteName]

London

Leeds

Newcastle

[LocationName]

Sales Office

Eng Office

[UserName]

Tom

Dick

Harry

[Comment]

Printer

Photocopier

Projector

[END]

Note: *The maximum number of entries for each field is SiteName (40), LocationName (70), UserName (40) and Comment (80).*

If the data is transferred using the Seaward **DataTransfer.exe**, a copy of this data can be saved as a text file as follows:

Click on Capture -> Start Capture.

Select a file for storing the configuration data.

On the PrimeTest 350, press F4 (Send).

When the data has all been transferred, click on Capture -> Stop Capture.

You now have the configuration data stored on your PC in a format that can be edited using a standard text editor such as Windows Notepad

The configuration data can be modified to add new Sites, Locations, Users or Comment information and sent back to the PrimeTest 350.

6.3.2 Receive Config Data

Follow the steps above in Send Config Data to run **DataTransfer.exe** and connect the PrimeTest 350 to your PC.

Click on File on the **DataTransfer.exe** menu and select Send File. This will open a window allowing you to select the text file containing your Site, Location, User and Comments configuration data. Select the require file and click on Open. The **DataTransfer.exe** application will now transfer the configuration file to the PrimeTest 350.

When the transfer is complete the PrimeTest 350 screen will display a message as shown below.

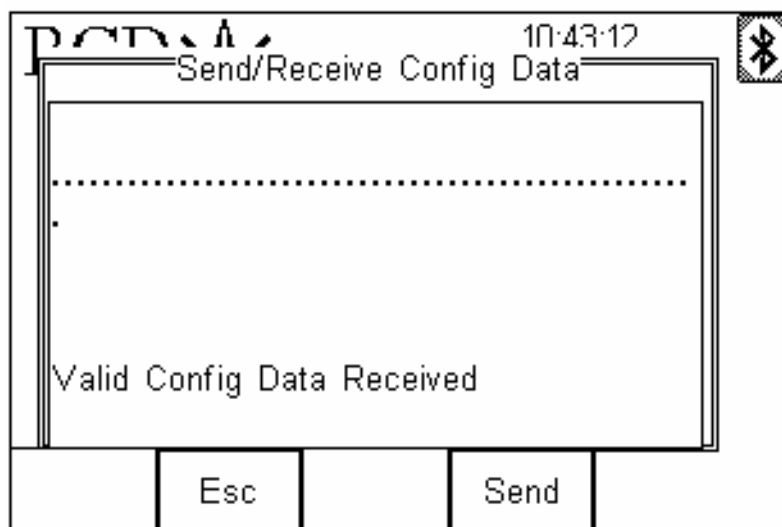

If the transfer is not successful, check that the format of the configuration file exactly matches that specified.

Note: *The Config file must be ASCII text and the last entry must be the [END] statement.*

6.4 Load Test'n'Tag Logo

A bitmap logo can be transferred to the PrimeTest 350 for use with the Seaward Test 'n' Tag print system.

The logo must be in .BMP with a maximum size of 320 pixels by 240 pixels.

Press **Menu** (F4), select **Data Transfer** using the arrow keys, select **load T 'n' T logo** and press **OK** (F4).

The PrimeTest 350 will now attempt to connect to the **Bluetooth Favourite** PC. When a connection has been established the display will be as shown below.

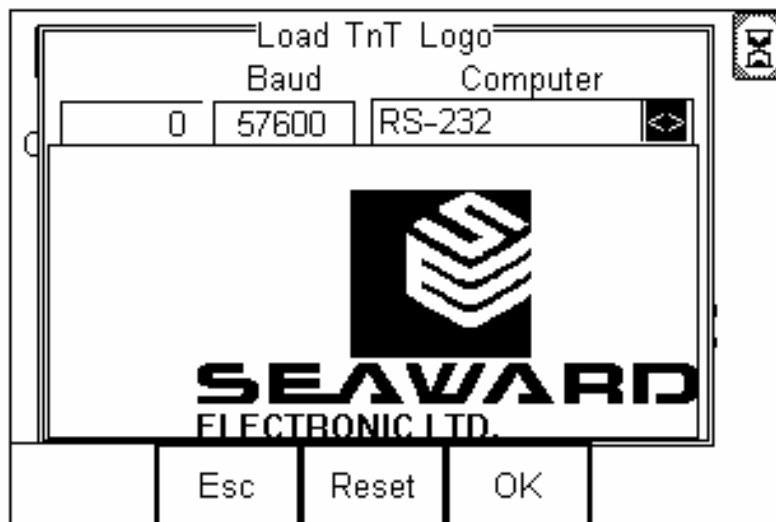

The PrimeTest 350 is now ready to receive data. The amount of data received is shown numerically on the top left of the display (0 in the screen shot above).

Note: *The file transfer can be made using the Seaward DataTransfer.exe application, or any suitable terminal emulator.*

7 View Saved Data

This function allows saved data to be reviewed and transferred to PC or Pass/Fail Label. From the main menu select **View Saved Data** and press **OK (F4)** to accept.

The display will now show a list of previously saved results as shown below.

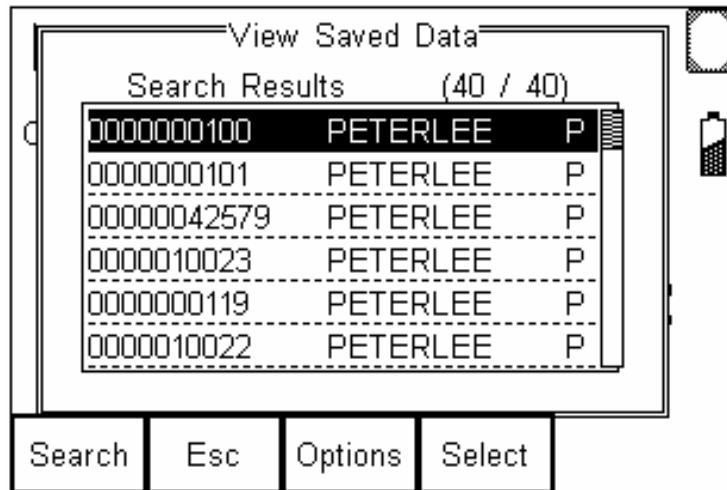

7.1 Search

The **Search (F1)** function is used to search through saved data. The search filter is shown below.

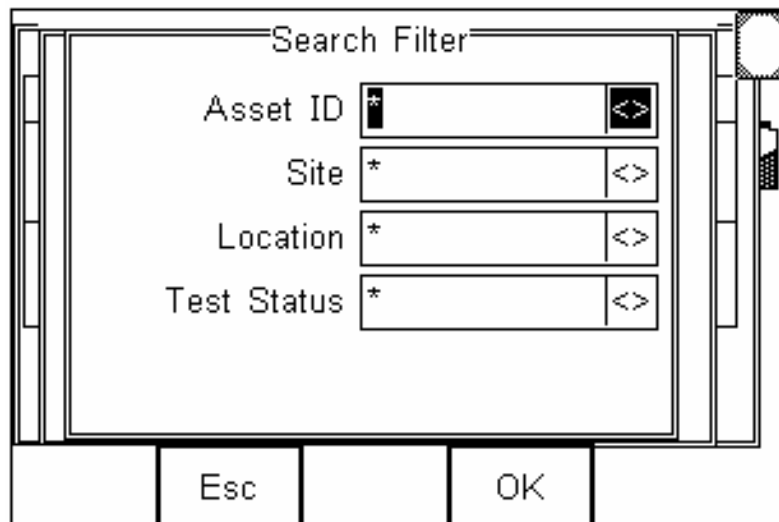

Saved data can be filtered by Asset ID, Site, Location or Test Status. Wildcards will return all records. In the example above, the search will return results for all Asset ID from all Sites, all Locations and all Test Status.

Note: *Filtered search can be used to selectively download or delete assets.*

7.2 Options

The **Options** (F3) key allows operations to be performed on results returned from the **Search** function.

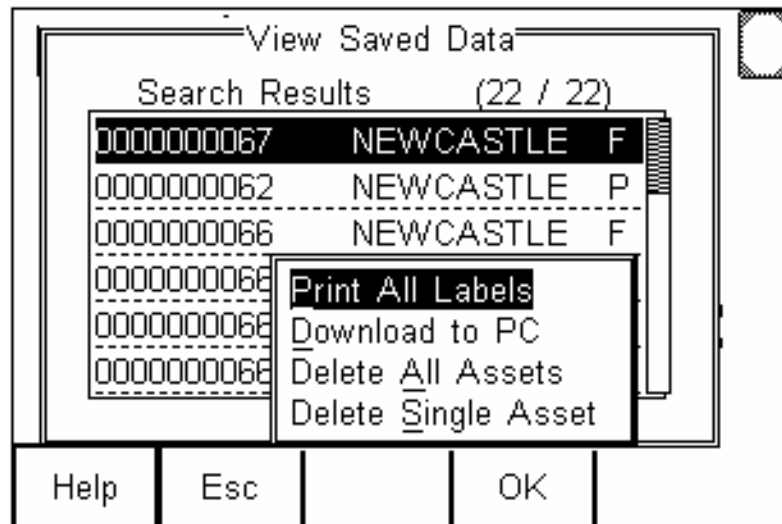

This allows selected records to be transferred label, downloaded to PC or deleted from memory. Individual assets can also be deleted by selecting Delete Single Asset.

Example: The following steps would delete all records for Site "My town."

- Menu (F4)
- Select View Saved Data
- OK (F4)
- Search (F1)
- Select Site "My town"
- OK (F4)
- Options (F3)
- Delete Assets

7.3 Viewing Test Details

Using the arrow keys, highlight the required record and press **Select** (F4). The Test Details for the highlighted record will now be displayed.

8 Memory Options

Memory options is used to view information about the PrimeTest 350 memory status. Press **Menu** (F4), use the arrow keys to select **Memory Options** and press **OK** (F4) to accept.

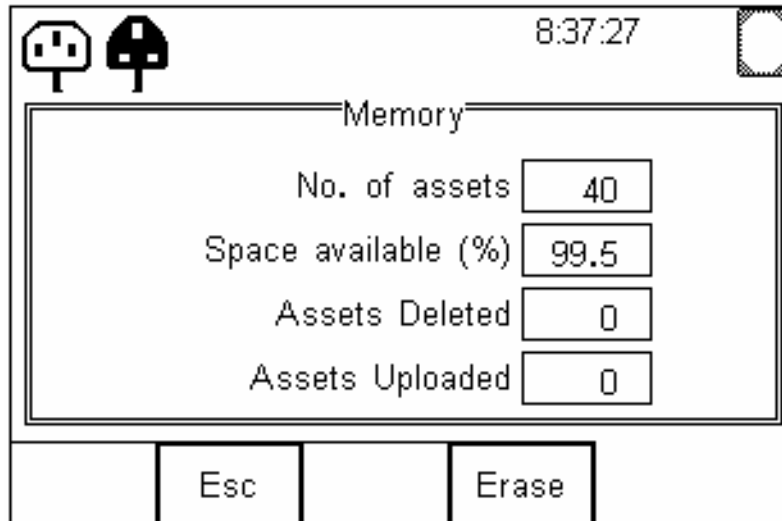

The display shows the number is asset records currently stored, the remaining memory space, number of assets deleted and number of assets in upload memory.

The nature of Flash memory is such that when records are deleted only the reference to the data is removed. The data still remains and will use memory space. The memory must be erased in order to release memory used by deleted records.

If the **Erase** (F4) key is pressed, a prompt is shown below. To erase the memory press **Yes** (F4).

Note: *The PrimeTest 350 has a total of 3Mbytes of memory for storing Test Results. This is typically enough for 8500 Assets.*

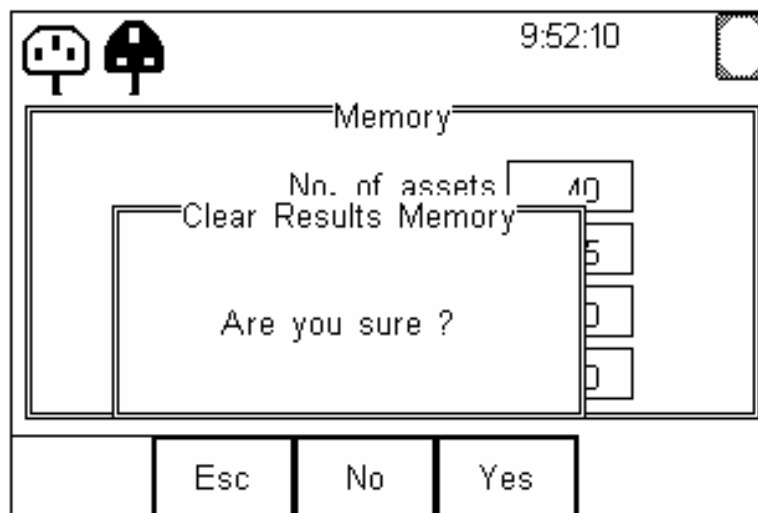

9 Configuration

The configuration facility is used to edit test sequences, set time and date and configure Bluetooth connections. It is also possible to restore factory settings using this function.

The configuration menu is located in the main menu list and presents the options shown below.

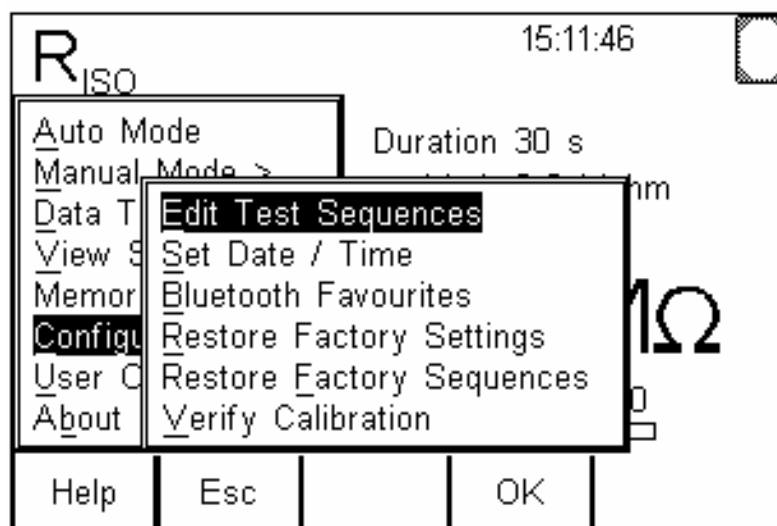

9.1 Edit Test Sequences

The PrimeTest 350 is supplied with 17 pre-configured test sequences covering a variety of type of electrical equipment. The test sequence editor can be used to modify test sequences or create new test sequences.

Note: *The PrimeTest 350 can store a total of 50 sequences, some of these are the pre-configured 'default' test sequences.*

Press **Menu** (F4), select **Edit Test Sequences** and press **OK** (F4) to open the **Edit Test Sequence** window. The **Options** (F3) key will display the available options as shown below.

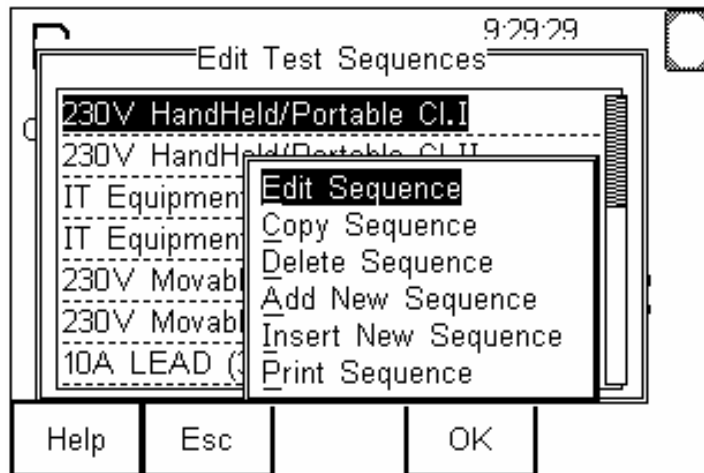

The PrimeTest 350 allows the user to Edit, Copy, Delete or Print an existing sequence or create a New sequence.

9.1.1 Edit Sequence

To modify an existing test sequence, select Edit Sequence from the menu shown above to open the sequence editor. Details on how to use the sequence editor are given in section 9.1.4.

9.1.2 Copy Sequence

A copy of an existing sequence can be made and subsequently modified to create a new sequence. The copy will be identical to the source and will have the same sequence name. To avoid confusion, the copy should be renamed by pressing **Edit** (F4). The copy can be further edit as described in section 9.1.4.

9.1.3 Delete Sequence

Sequences can be deleted if no longer required to make space for new sequences. A further prompt is presented to avoid accidental deletion.

Note: If a sequence is accidentally deleted the factory Sequences can be restored by following the steps in section 9.5

9.1.4 Creating a New Sequence

A new test sequence can be created using either "Insert New Sequence" or "Add New Sequence". "Insert" will insert a blank test sequence at the currently highlighted position in the list. "Add" will add a blank test sequence onto the end of the lists.

The default name for a new sequence is "Test Sequence n" where n is the next available location. There are 17 factory sequences and so the first time New Sequence is used the default name is "New Sequence 18".

To build the new sequence, use the arrow keys to highlight the sequence name and press **Edit** (F4) to open the sequence editor as shown below.

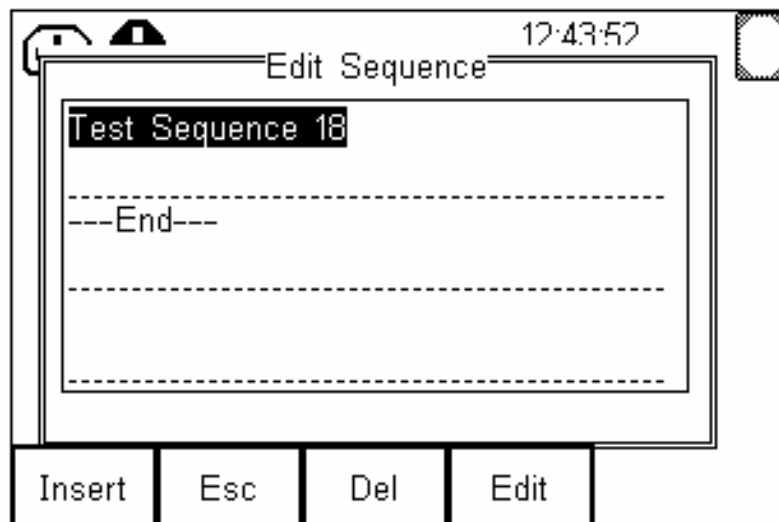

Pressing **Edit** (F4) allows the sequence name to be changed.

To insert a test into the sequence, press **Insert** (F1) to open the **Insert a Test** window and use the left or right

arrow key to show the list of available test.

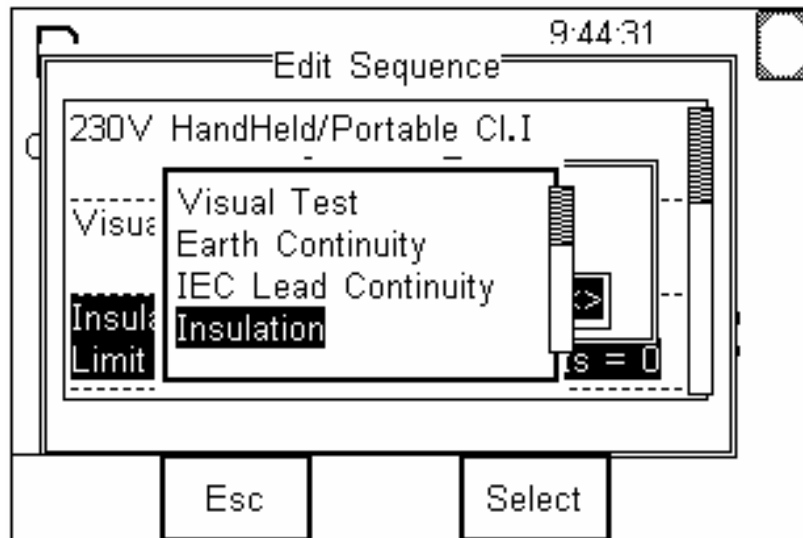

Now scroll through the list of default tests until the required test is highlighted and press **Select** (F4).

Note: A unique feature of the PrimeTest 350 is the ability to create User defined tests. For full details of this feature refer to section 9.1.5

If the selected test has user definable parameters the Edit New Test window will open e.g. if an Insulation test is selected the window below will open.

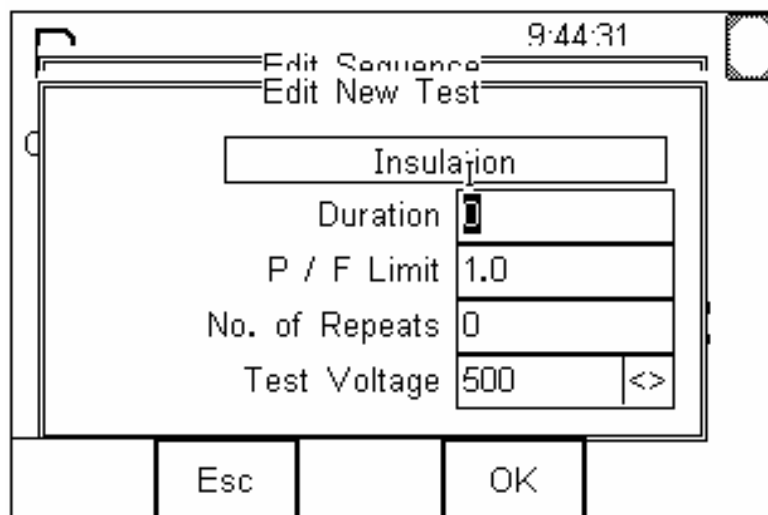

The required parameters can be chosen by selecting the appropriate field and entering the required value using the keypad.

Note: A decimal point is entered by pressing the F1 key.

In the example Insulation Test above, the required duration in seconds, pass/fail threshold in MΩ and number of times the test is to be repeated can be entered using the keypad. Also the test voltage (250v or 500v) can be selected using the left / right arrow keys. When the required data has been entered, press **OK** (F4) to accept.

The new test will now appear in the sequence with the values entered for each parameter shown.

To add further tests, position the highlight bar at the required point in the sequence and press **Insert** (F4).

Note: Tests are inserted into the sequence in the position above the highlight bar.

9.1.5 User Tests

The PrimeTest 350 has the unique ability to create user-defined tests. When using the test sequence editor, these appear in the list of available tests as shown below.

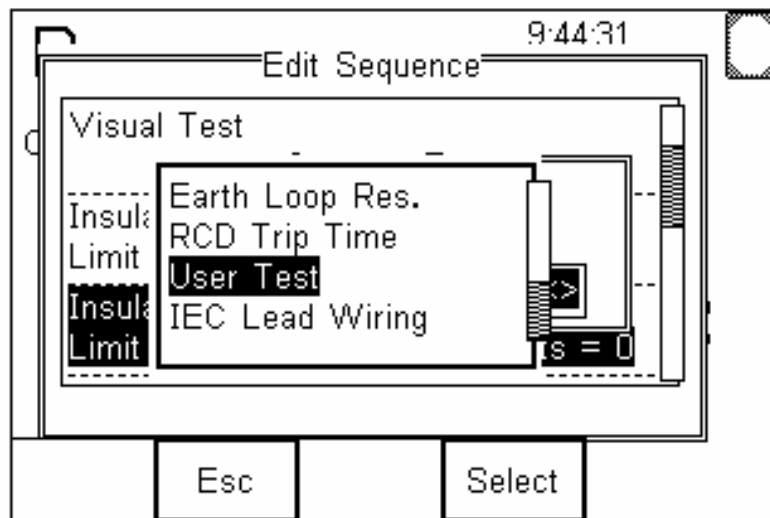

The User test name and units of measurement are fully configurable to allow the PrimeTest 350 to record both electrical and non-electrical measurement data.

Note: The results of a User Test are stored within a test record for post processing.

User Tests can be added to factory test sequence or new user defined sequences.

User tests are fully compatible with Seaward PATGuard software.

To insert a User Test in a new sequence follow the step in section 9.1.4 to open the Inset a Test window and highlight **User Test**. Press Select (F4) to insert a User Test and display the Edit User Test screen shown below.

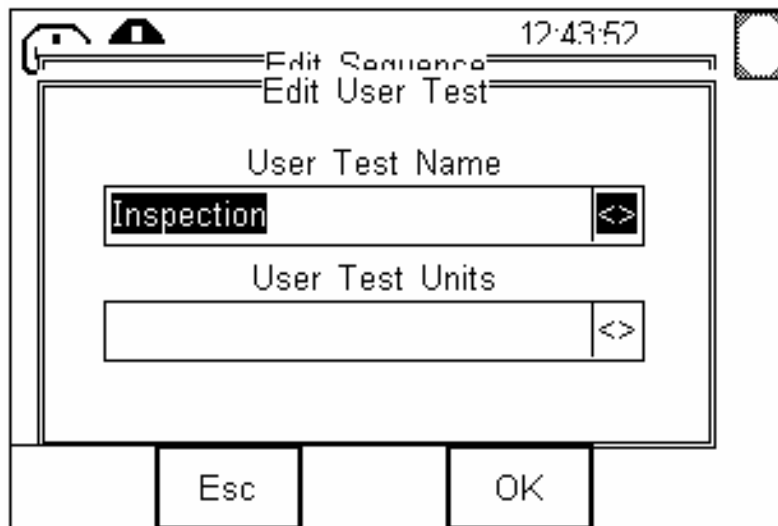

The User Test Name will now be highlighted. For convenience a selection of commonly used names have been entered. Use the left/right arrows to scroll through the factory-programmed names or enter a new name using the keypad and edit function keys.

Now, using the down arrow, move the highlight bar to the User Test Units field. Again, a selection of commonly used units is available for convenience. Select the required units using the left/right arrow or enter new units using the keypad.

The screen below shows a User Test created to record microwave leakage in mW/cm^2 .

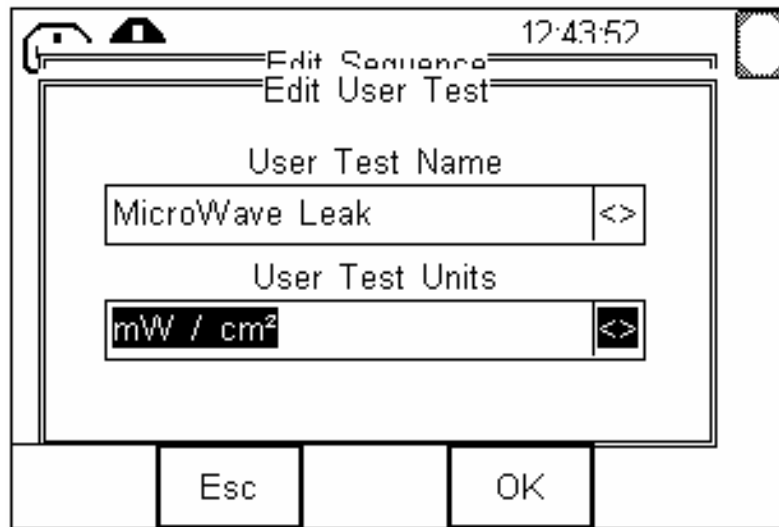

An example test sequence created to measure microwave leakage is shown below.

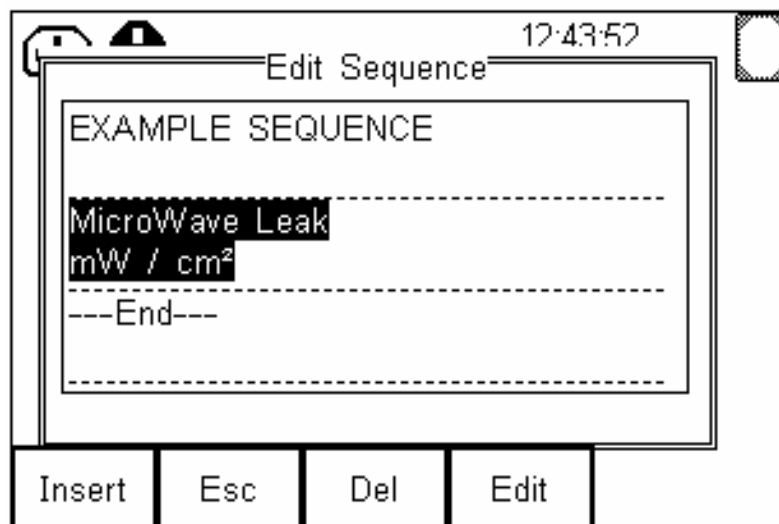

When this test sequence is run using the Automatic Test Mode described in section 13, the User Test will prompt for data input as shown below.

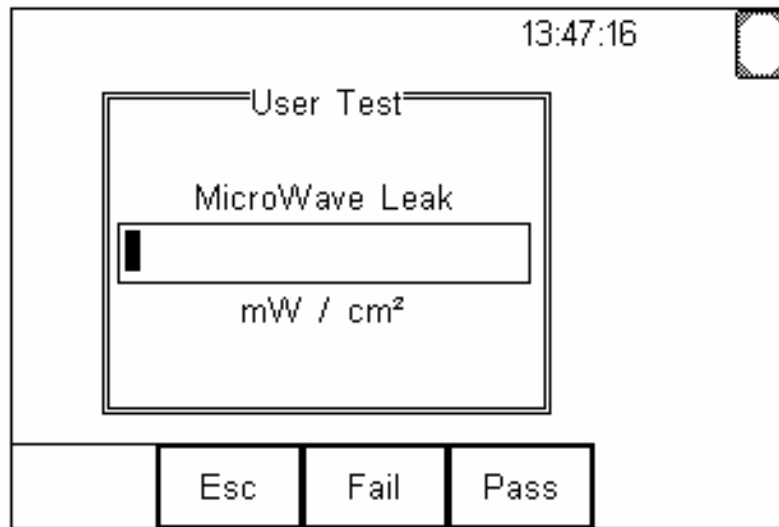

The user is now required to enter a measurement and select a Pass or Fail for this measurement. The measurement and Pass or Fail information is now stored as part of the test record.

9.1.6 Print Sequence

This feature allows test sequences to be sent to the **Bluetooth Favourite** printer. The print format in this case uses ASCII characters.

9.2 Set Date/Time

The Primetest 350 is equipped with a real-time clock. To alter the time or date press **Menu** (F4), select configuration, Set Time/Date and press **OK** (F4). Select the values to be changed using the arrow keys, enter the required value using the keypad and press **OK** (F4) to accept.

Note: Use F1 ':' to separate the hours and minutes.

9.3 Bluetooth Favourites

Refer to section 12 for full details on using Bluetooth.

9.4 Restore Factory Settings

The factory settings can be restored at any time using this function. The Site, Location and User list will be restored to the factory settings.

Note: *User defined Site, Location and Users lists will be removed.*

9.5 Restore Factory Sequences

The factory test sequences can be restored at any time using this function.

Note: *New or modified test sequences will be removed if the factory sequences are restored.*

9.6 Verify Calibration

After 12 months have elapsed since the last verification or calibration, the PrimeTest 350 real-time clock will remind users that verification is required. Contact an approved Service Agent to arrange verification.

Note: *Verify Calibration is password protected and can only be accessed by an approved Service Agent.*

10 User Options

Each User has the option to customise aspects of the PrimeTest 350 in accordance with their needs or preferences. Changes to the set up of the unit will be stored against the name of the active User.

To access the User Options, press **Menu** (F4). Use the arrow keys to highlight and select **User Options**. This will display the menu shown below.

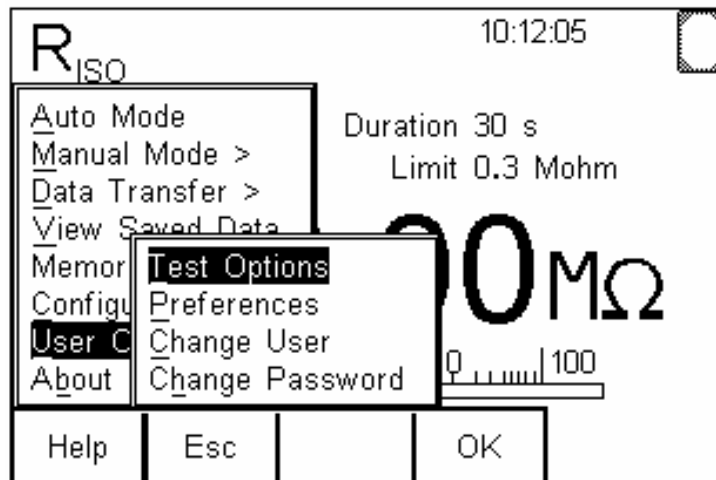

10.1 Test Options

Test Options is used to configure the Asset ID counter, Test Failure and After Test options and the headings used in for the comments fields. The default Test Options are shown below.

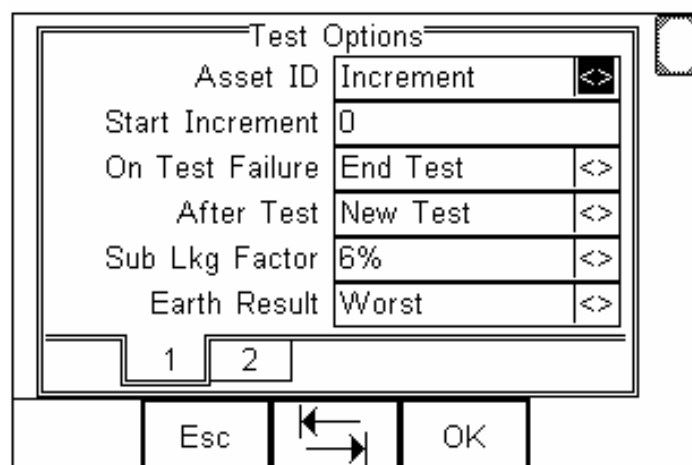

Note: The F3 key can be used to switch onto a second screen with more Test Options.

10.1.1 Asset ID

This can be set to automatically increment the ID number at the end of each test, present a blank field or Repeat Last ID.

10.1.2 Start Increment

Enter an Asset ID here, this will be used as the start number for the auto increment feature.

10.1.3 On Test Failure

In the event of a test failure during an automatic sequence, the PrimeTest 350 can be configured to either End Test, which will terminate the test sequence or Fail Menu, which will present a list options.



Fail menu gives the option to restart the test, restart the appliance (from the first test), end the appliance (and record a fail result) or abort the appliance.

Note: *Restart Test is useful for coping with situations such as forgetting to connect the earth continuity probe. End Appliance will record a Fail result whereas Abort Appliance does not record a result.*

10.1.4 After Test

There is a choice of 4 actions to be carried out at the end of a test sequence.

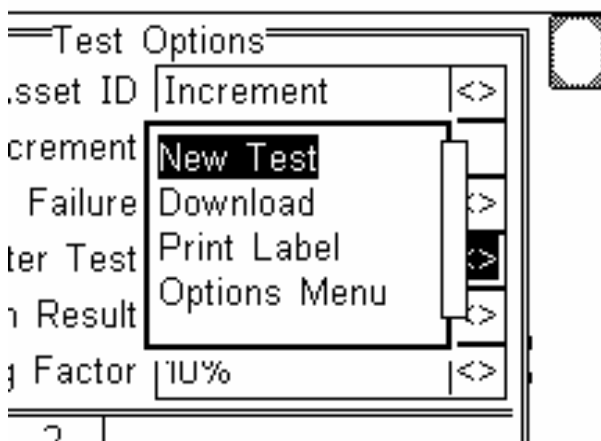

New Test will auto save at the end of a test sequence and then open the Asset Details window ready for a new test.

Download will auto save at the end of a test sequence and then open the Download to PC window. When the Download to PC window is closed the tester will proceed to the next test and open the Asset Details window.

Print Label will auto save at the end of a test sequence and then open the Print Label window. When printing is complete, the tester will proceed to the next test and open the Asset Details window.

Options Menu will auto save at the end of a test sequence and then open the Test Details window. Pressing **New Test** (F2) will proceed to the Asset Details window, ready for a new test. Pressing **Options** (F3) will open a list of options including View Results, Information, Print Label, Print Result, and Write RFID Tag.

Test Details			
Asset ID	123459		
Site	NEWCASTLE		
Location	SALES		
Tested by	JIM		
Tested on	14 Oct 2005 14:06		
Status	Failed	Test Type	FULL
Test Period (months)	12		

New Test	Options		
----------	---------	--	--

10.1.5 Sub Lkg Factor

- can be set to 0%, 6% or 10%. This is equivalent to a Substitute Leakage reading at 230, 244 or 253 volts.

10.1.6 Earth Result

- can be set to “Worst” or “Last”. If set to “Worst” then the result of an Earth continuity test will be taken as the highest reading during the test. If set to “Last” then the result will be the last reading taken.

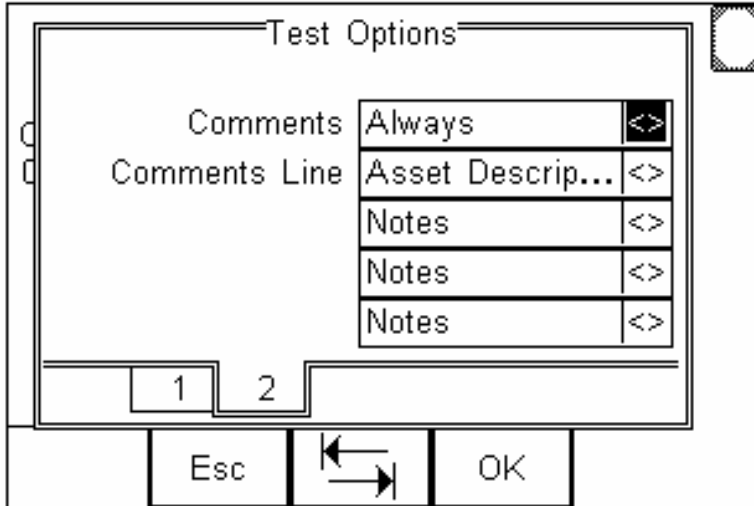

10.1.7 Comments

Press F3 to switch to the Comments screen.

- can be set to open the comment window: always, if the result is a pass, if the result is a fail or never.

10.1.8 Comments Line

- allows the field descriptor for each of the four comment lines to be changed to show Notes, Asset Description, Asset Group, Make, Model or Serial Number as required.

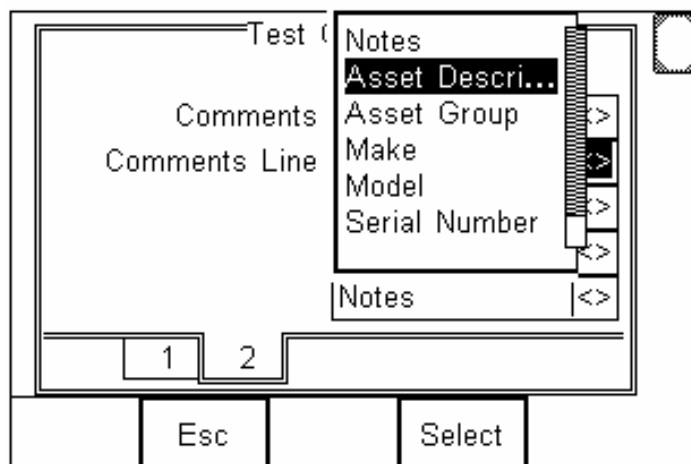

10.2 Preferences

There are a number of general features within the PrimeTest 350 that can be setup/customized for individual users

Press **Menu** (F4). Use the arrow keys to highlight and select **User Options** followed by **Preferences**. Press **OK** (F4).

The first field shows the User Name. Any changes made to these preferences will be stored against this User only. Use the up/down arrow keys to highlight the desired feature. Once the preferences have been setup press **OK** (F4) to store the changes. **Esc** (F2) will exit this screen without saving the changes.

10.2.1 Display Time

This feature allows the time to be displayed on the LCD. Use the left/right arrow keys to adjust.

10.2.2 Set Contrast

This feature allows the contrast of the display to be set. Use the left/right arrow keys to adjust.

10.2.3 Auto Off Time (mins)

The PrimeTest 350 will power itself off after a period of inactivity. This time is set here. Use the left/right arrow keys to adjust the value between 1 minute and 10 minutes.

10.2.4 Data Entry

In Automatic mode it is required that an asset id number be entered prior to starting a test. This can be done either by using the keypad only, using the keypad and a barcode scanner or using the keypad and an RFID wand. Use the left/right arrow keys to set.

Note: *If data entry is set to barcode or RFID, the unit will automatically try to connect to a barcode scanner or RFID wand via the internal Bluetooth module – if neither is available this feature is simply draining the batteries un-necessarily. In this instance it is recommended that the unit be set to Keypad only.*

10.2.5 Backlight Mode

The backlight on the PrimeTest 350 can be set to either, never come on, stay on permanently or come on in Power Save mode. Power save mode ensures that the backlight comes on when a key is pressed and stays on for several seconds before switching itself off again. Use the left/right arrow keys to set.

10.2.6 Type of User

The user type can be set to Novice or Expert. For Novice users, additional help prompts are provided during test sequence.

10.2.7 Tones

The **Tones** (F3) key will select a screen which will allow the various tones to be set up, i.e. Beep on Key Press or Beep on Warning etc. Use up/down arrow keys to highlight desired function and the left/right arrow keys to set.

10.3 Change User

The PrimeTest 350 has a password protected User system to prevent unauthorised modifications to the configuration.

There are two levels of access. When logged in as **Admin** full access is available to all configuration options as shown below.

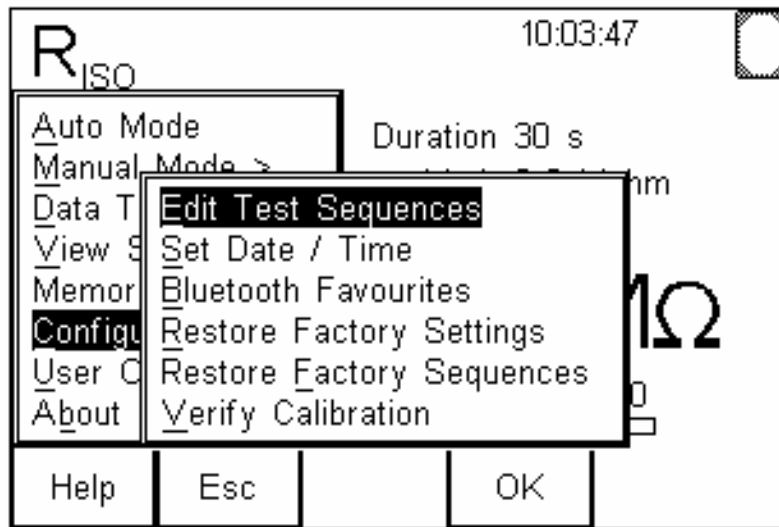

The **Change User** option is used to change the active User.

From the User Options menu, select Change User and press OK (F4). The screen will now be as shown below.

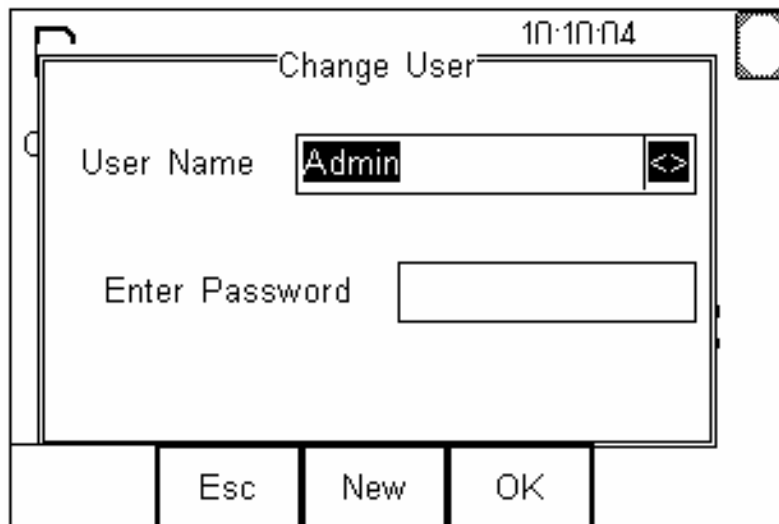

Use the left/right arrow keys to change to an existing User Name or press **New** (F3) and type in a new name as shown below.

The screenshot shows a terminal window titled "Change User" with a timestamp of "13:27:44". Inside the window, there is a "User Name" field containing the text "FRED" and a cursor. Below it is an "Enter Password" field which is currently empty. At the bottom of the window, there are four buttons labeled "Shift", "Esc", "Del", and "Enter".

Press **OK** (F4) to accept the new user name.

This new user will have no password set as default. If a password is required see **section 10.4 – Change Password**. Press **OK** (F4) to finish.

Note: If a User has been set up along with a password this password must be entered in the Password field of the Change User screen. The unit will not allow this User to be selected if the password is incorrect.

As the active User has been change from Admin, access to the configuration menus has been removed. When logged in as any other **User** access is restricted, as can be seen below, where the unavailable configuration options have a line through them.

This feature allows an administrator to configure the instrument and then prevent other users from making modifications.

Note: Access for other Users is only restricted after a password has been set for the Admin User.

If Admin password is blank, all Users have full system access.

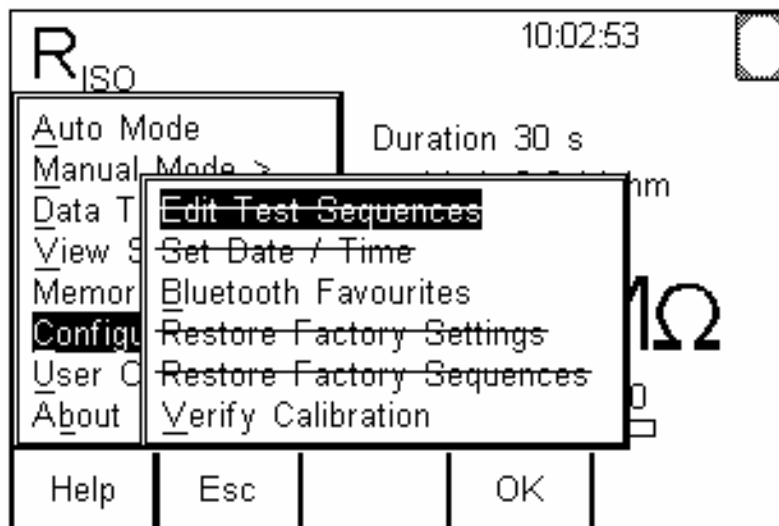

10.4 Change Password

Note: The default password for all Users is blank.

First ensure that the required active User name has been selected as described in section 6.3.

Press **Menu** (F4). Use the arrow keys to highlight and select **User Options** followed by **Change Password**. Press **OK** (F4). The screen now shows the Change Password display.

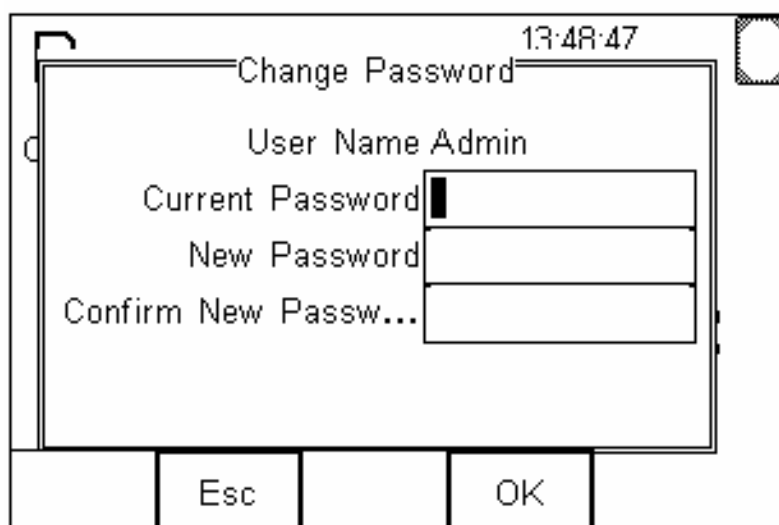

Enter the current password into the first field – if no password is set then leave this field blank.

Use the arrow keys to move to the New Password field. Type the new password. Use the arrow keys to move to the Confirm New Password field. Enter the new password again. Press **Enter** (F4) followed by **OK** (F4) to finish.

Note: *If there are any mistakes in this screen the unit will not allow the new password to be stored. Esc (F2) will exit this screen without saving changes.*

11 Manual Test Functions

Once in Manual mode the tester can perform one of seven tests as described below. The desired test can be selected by using either the left/right arrow keys or the menu.

An icon displayed in the top left of the LCD display identifies the selected test.

11.1 Earth Continuity



Refer to fig. 3.

This test is applicable to Class I equipment only.

This test will check that the connection between the earth pin in the mains plug of the appliance and the metal casing of the appliance is satisfactory and of sufficiently low resistance.

A DC test current of $\pm 200\text{mA}$ is applied between the earth pin of the mains supply plug and the earth bond test lead clip/probe. The worst-case result is shown on the display.

Press **Setup** (F3) to set the Test Duration and Pass/Fail limit. Use the arrow keys to highlight and set. The pass/fail limit can be calculated whilst in this mode by pressing **Calc** (F3). Enter the type and length of cable and a new limit will be calculated. This can be overridden by selecting the limit from the list. Press **OK** (F4) when complete. **Esc** (F2) will exit setup mode without saving changes.



If an Earth Bond lead other than that supplied with the PrimeTest 350 is to be used for this test it's resistance can be 'nulled' out by fitting the probe end into the EUT earth socket and pressing F2. The icon above will be displayed on the left side of the LCD to indicate this has taken place. Press F2 again to cancel.

Note: switching off the PrimeTest 350 will **not** cancel the 'probe zero'

Fit the Appliance mains plug into the EUT outlet. Connect the Earth Bond lead to the appliance metal part. Press the green **START** key to begin the test. The test will run for the duration set. To end the test before the test time expires press the red **STOP** key.

Note: *The PrimeTest display will show real time measurements during an Earth Continuity test.*

The result shown at the end of the test can be either the worst reading or the last reading, depending on the Test Options setting.

If set for "Worst" then the value is the peak value measured during the test. This can be used to detect momentary break in the earth path e.g. damaged power cords or loose mains plug connections.

If set for "Last" then it is the last value measured. This can be useful JW

A Pass or Fail is determined by comparing the peak value measured during the test with the pre-set limit.

11.2 Insulation Resistance

R_{ISO}

Refer to Fig. 4

This test is applicable to Class I and Class II equipment.

This test is used to verify that the mains supply pins are adequately insulated from earth.



During this test, 250V or 500V D.C. is applied between the earth pin and both the live and neutral pins of the appliance mains supply plug.

Press **Setup** (F3) to set the Test Duration, Pass/Fail limit and test voltage. Use the arrow keys to highlight and set. Press **OK** (F4) when complete. **Esc** (F2) will exit setup mode without saving changes.

Press **Class** (F2) to set the class of the appliance under test. For a class II appliance the probe symbol will be displayed at the top of the LCD display.

For both Class 1 and Class II appliances fit the Appliance mains plug into the EUT outlet. For Class 2 appliances only connect the Earth Bond lead to the appliance. Press the green **START** key to begin the test. The test will run for the duration set or until the red **STOP** key is pressed.

11.3 Substitute Leakage

I_{SUB} Refer to Fig. 5
This test is applicable to Class I and Class II equipment.

This test is used to verify that the mains supply pins are adequately insulated from earth.

During this test, 40V A.C. is applied between the earth pin and both the live and neutral pins of the appliance mains supply plug.

Press **Setup** (F3) to set the Test Duration and Pass/Fail limit. Use the arrow keys to highlight and set. Press **OK** (F4) when complete. **Esc** (F2) will exit setup mode without saving changes.

Press **Class** (F2) to set the class of the appliance under test. For a class II appliance the probe symbol will be displayed at the top of the LCD display.

For both Class 1 and Class II appliances fit the Appliance mains plug into the EUT outlet. For Class 2 appliances only connect the Earth Bond lead to the appliance. Press the green **START** key to begin the test. The test will run for the duration set or until the red **STOP** key is pressed.

During this test, a nominal voltage of 40V a.c. rms is applied between the earth pin and both the live and neutral pins of the appliance mains supply plug.

The tester measures the current that flows and scales the result to display a guide to the current that would flow if the test voltage had been the nominal mains supply voltage. See 10.1.5 Sub Leakage scale factor. The Tester displays the result in milliamps (mA).

This test can prove useful in situations where neither conventional insulation nor flash tests are acceptable methods of testing the insulation of the appliance. Please note that values for substitute leakage may differ substantially from that of conventional earth leakage tests because of the way that the test is performed (e.g. it will be affected by the presence of Neutral-to-Earth suppression capacitors).

11.4 Protective Earth (PE) Conductor Current

I_{PE} Refer to Fig 5
This test is applicable on Class I Equipment.

The Protective Earth (PE) Conductor Current Test displays the current flowing in the earth conductor of the EUT. This is measured by looking at the difference in current flowing in the live and neutral conductors.

The Tester displays the result in milliamps (mA).

In the top left area of the screen, the tester also displays the EUT load in kVA.



Warning: Always test the earth continuity and insulation resistance before performing a PE Conductor Current test.



Warning: Always check that an appliance with moving parts (e.g. an electric drill) is safely mounted to avoid risk of damage to equipment or personnel.



Attention: Avoid prolonged, repeated use at full load (16A) and excessive test duration as this may reduce the life of the unit.

Press **Setup** (F3) to set the Test Duration and Pass/Fail limit. Use the arrow keys to highlight and set. Press **OK** (F4) when complete. **Esc** (F2) will exit setup mode without saving changes.

Fit the power lead supplied to the PrimeTest 350 and plug the other end into a suitable mains outlet. Fit the Appliance mains plug into the EUT outlet. Press the green **START** key to begin the test.

Pre-load check - If the potential load current is too high, a warning message appears, preventing the user from continuing. This message will be displayed if a Live to Neutral short exists or the EUT mains current consumption is too high.

Internal Relay checks – Before applying power to the EUT the PrimeTest 350 performs a series of internal safety checks to verify that internal relays are working properly.

Once the test has started it will run for the duration set. To end the test sooner, press the red **STOP** key.

11.5 Touch Current

I_t

Refer to Fig 6

This test is applicable on Class I and Class II Equipment.

The Touch Current Test displays the current that would flow if a person touched the appliance. This is based on a 'body model' of 2kohm as per IEC61010.

The Tester uses the black test probe to detect any current flowing from accessible conductive parts of the

appliance to earth via the 'body model'. The Tester displays the result in milliamps (mA).

In the top left area of the screen, the tester also displays the EUT load in kVA.



Warning: Always test the insulation resistance before performing a Touch Current test.



Warning: Always check that an appliance with moving parts (e.g. an electric drill) is safely mounted to avoid risk of damage to equipment or personnel.



Attention: Avoid prolonged, repeated use at full load (16A) and excessive test duration as this may reduce the life of the unit.

Press **Setup** (F3) to set the Test Duration and Pass/Fail limit. Use the arrow keys to highlight and set. Press **OK** (F2) when complete. **Esc** (F2) will exit setup mode without saving changes.

Fit the power lead supplied to the PrimeTest 350 and plug the other end into a suitable mains outlet. Fit the Appliance mains plug into the EUT outlet. Connect the Earth Bond lead to the appliance metal part. Press the green **START** key to begin the test.

Pre-load check - If the potential load current is too high, a warning message appears, preventing the user from continuing. This message will be displayed if a Live to Neutral short exists or the EUT mains current consumption is too high.

Internal Relay checks – Before applying power to the EUT the PrimeTest 350 performs a series of internal safety checks to verify that internal relays are working properly.

Once the test has started it will run for the duration set. To end the test sooner, press the red **STOP** key.

11.6 Earth Loop Resistance

Zs Refer to Fig 7
This test is applicable to the mains electrical installation.

This test will check the resistance of the Live to Earth circuit of the installation.



Warning: The black probe must not be used when performing an Earth Loop Resistance test.

The test duration for this test is fixed at approximately 10 seconds.

Fit the power lead supplied to the PrimeTest 350 and plug the other end into the mains outlet under test. To start the test, press the green **START** button.

While the PrimeTest 350 performs the test the LCD will show 0.0Ω flashing. When the test is complete measured value will be displayed.

11.7 RCD Trip Time

RCD Refer to Fig 7
This test is applicable to the mains electrical installation.

This test will pass a sinusoidal current of 30mA down the earth conductor and measure the time it takes for the mains supply to trip.



Warning: The black probe must not be used when performing an RCD test.

Fit the power lead supplied to the PrimeTest 350 and plug the other end into the mains outlet under test. To start the test, press the green **START** button. The PrimeTest 350 will produce a test current of 30mA r.m.s in the protective earth of the supply. The test will commence at the start of a positive half cycle.

The RCD will trip. The time taken to trip will be displayed.

Reset the RCD. When the PrimeTest 350 detects that power has been re-applied it will commence the negative half cycle test. The PrimeTest 350 will again produce a test current of 30mA r.m.s in the protective earth of the supply. The test will commence at the start of a negative half cycle.

The RCD will trip. The time taken to trip will be displayed.

11.8 IEC Lead



Refer to Fig. 8

IEC leads are tested in 3 stages, continuity, insulation and polarity.

The test durations for the each of the 3 stages are fixed. Press **Setup** (F3) to set the Pass/Fail limits for Continuity and Insulation stages. Use the arrow keys to highlight and set. The pass/fail limit for the continuity stage can be calculated **Calc** (F2). Enter the type and length of cable and a new limit will be calculated. This can be overridden by selecting the limit from the list. Press **OK** (F4) when complete. **Esc** (F2) will exit setup mode without saving changes.

To perform an IEC lead test, connect the IEC socket side of the lead into the IEC inlet plug on the PrimeTest. Connect the mains plug side of the lead into the EUT socket.

To start the IEC lead test, press the green **START** button. The earth continuity resistance for the lead is measured at $\pm 200\text{mA}$. The display indicates the highest resistance and the pass/fail status. If this resistance is less than the pass/fail limit, then the insulation resistance will be measured.



During an insulation resistance measurement, a high voltage is applied between Live/Neutral and the common of the IEC lead.

The insulation resistance of the lead is measured over a period of 2 seconds. The display shows the final reading and the pass/fail status. If the insulation resistance is greater than the pass/fail limit, then the lead polarity will be checked.

The lead “wiring” stage checks for short and open circuit conditions on the live and neutral conductors. The display shows the final result and the pass/fail status.

12 Bluetooth Functions

The PrimeTest 350 has built in Bluetooth connectivity. It is possible to connect a variety of devices to the PrimeTest 350 via the Bluetooth link:

PC – required to download stored data, to upload Test'n'Tag logos, to upload configuration, test and program data.

Barcode Scanner – required for scanning asset labels

Printers – required for printing pass/fail labels and barcode labels.

RFID Wand – required for reading from and writing to RFID tags.

The PrimeTest 350 will automatically search for the appropriate accessory or device when function requiring a connection is performed.

Note: *When attempting to print a pass/fail label the PrimeTest 350 will automatically connect to the printer assigned in the Bluetooth Favourites.*

Similarly, when data is required from a barcode scanner, the PrimeTest 350 will automatically connect to the barcode scanner assigned in the Bluetooth Favourites.

12.1 Bluetooth USB Adapter

The PrimeTest 350 can be supplied with a Bluetooth USB Adapter. This device can be used to add Bluetooth connectivity to a PC or Laptop which is not already Bluetooth enabled. Full installation instructions are provided in the Bluetooth USB Adapter Setup guide.

Note: *The adapter must not be plugged into the USB port until specifically requested to do so by the install program.*

12.2 Bluetooth Favourites

In order for the PrimeTest 350 to automatically connect to the correct Bluetooth accessory, details of that accessory must be entered into the Bluetooth Favourites list.

The Bluetooth Favourites list comprises of four sub-lists (device types), each of which can store up to 3 accessories of the same type. The four sub-lists are shown below:

Barcode Scanner
Printer
Computer
RFID wand

Press **Menu** (F4). Use up/down arrow keys to highlight **Configuration**, press right arrow key to select. Use up/down arrow keys to highlight **Bluetooth Favourites**, press **OK** (F4) to select.

The following shows how to add a Computer to Bluetooth Favourites.

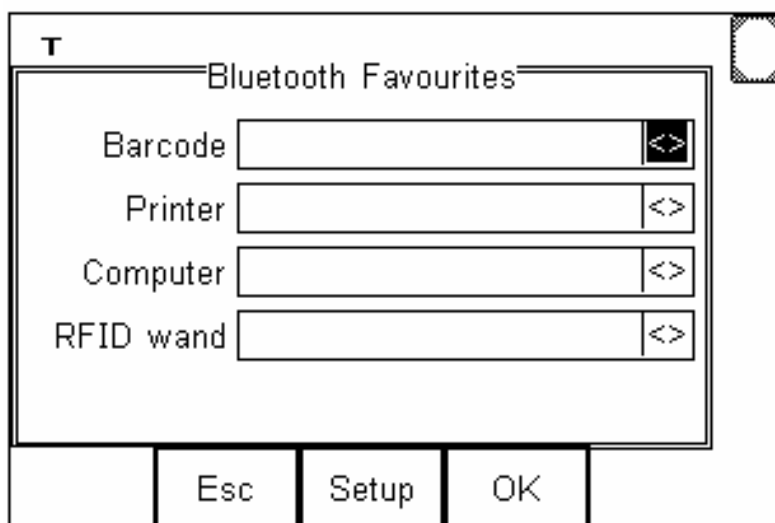

Use the up/down arrow keys to highlight the device type (in this case Computer) then press **Setup** (F3).

Make sure that the device you want to add to your new favourites is switched on.

Press **Search** (F1). The PrimeTest 350 will search for all discoverable Bluetooth devices within a 10m range. The time taken to perform the search will vary depending on the number of Bluetooth devices in range.

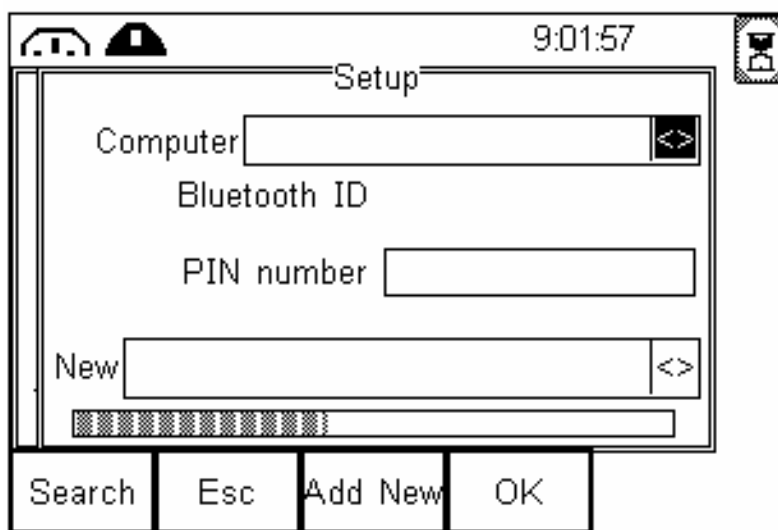

Wait for the progress bar to complete.

Use the arrow keys to highlight the field labelled “New” and press the left or right arrow to open the list if devices which have been found during the search.

Note: If more than 10 Bluetooth devices have been found the list will show the last 10 devices found.



In the example above, the search has identified Bluetooth devices named “GX30” and “My Laptop.”

Note: *If the required device is not shown, check that it is powered on with the Bluetooth function active then repeat the search.*

Note: Some Bluetooth devices do not report a recognisable name and may cause confusion when setting up Favourites. Turn off or disable unused Bluetooth devices when configuring Favourites.

Use the arrow keys to highlight the required device (in this case My Laptop) and press **Select** (F4). My Laptop is now placed in the “New” field as shown below.

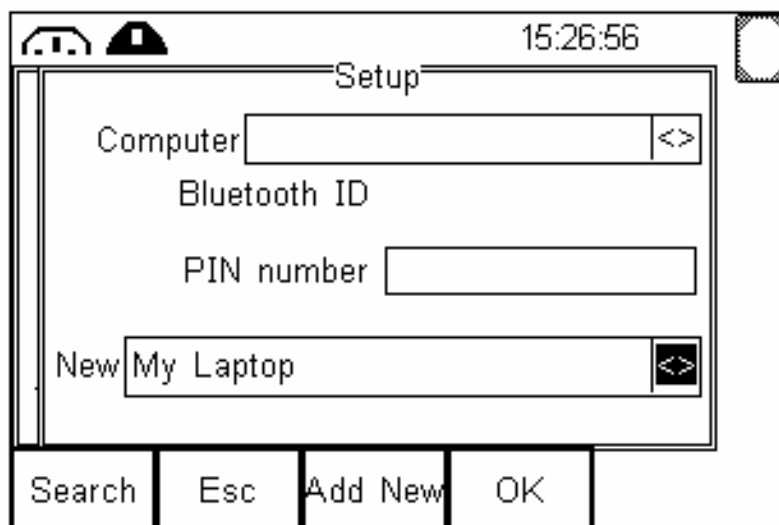

Press **Add New** (F3) to add “My Laptop” to the Favourite Computer list.

To add further devices to the list of available computers select the **New** again, use the arrow keys to select the required device and press **Add New** (F3) to add the chosen device.

Note: *If devices that are not required can easily be removed by selecting the Computer field, pressing the left of right arrow key to open the list, highlighting a device and pressing Del (F3).*

A PIN number can be entered if required by the device to be added to the Favourites list.

Note: *Seaward accessories do not require a PIN. For other Bluetooth devices refer to the manufacturers documentation.*

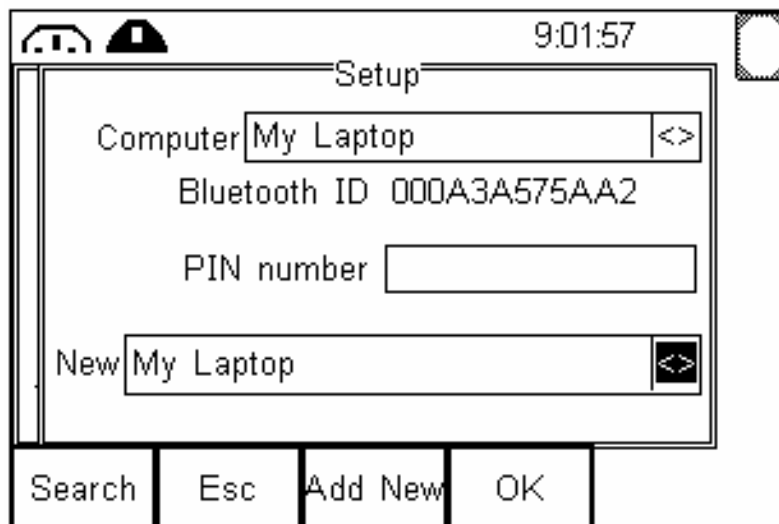

“My Laptop” has been added to the Computer field with **Bluetooth ID**.

Note: *All Bluetooth devices have a unique ID. The Bluetooth ID is shown when a device is added to the Favourites list.*

Press **OK** (F4) to return to the previous screen.

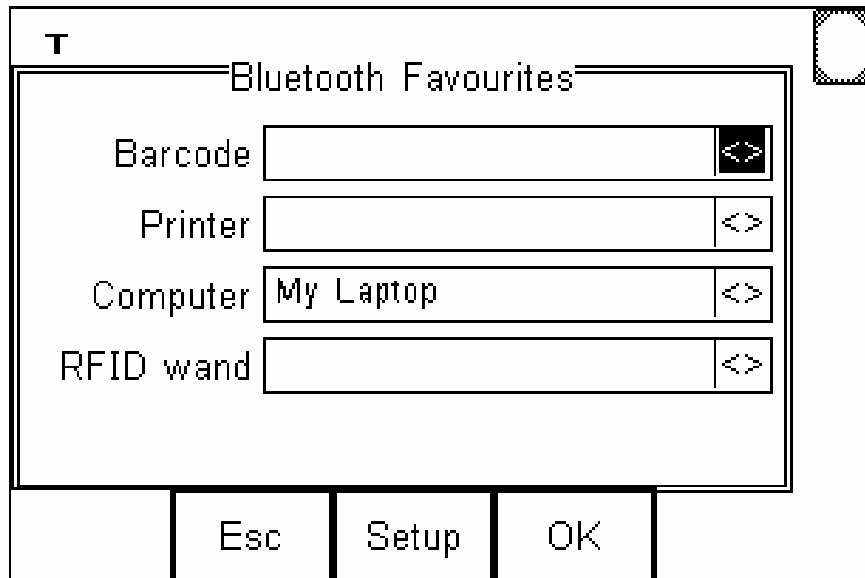

“My Laptop” is now a Bluetooth Favourite and the PrimeTest 350 will automatically establish a connection with “My Laptop” when using functions that communicate with a computer e.g. downloading records to PATGuard.

Note: Press **Esc** (F2) to exit without saving changes.

If necessary, you can select another device to be set up.

When all your favourite devices have been set up, press OK and they will be saved.

12.3 Bluetooth Connection to a Printer

The following shows how to add a Printer to Bluetooth Favourites.

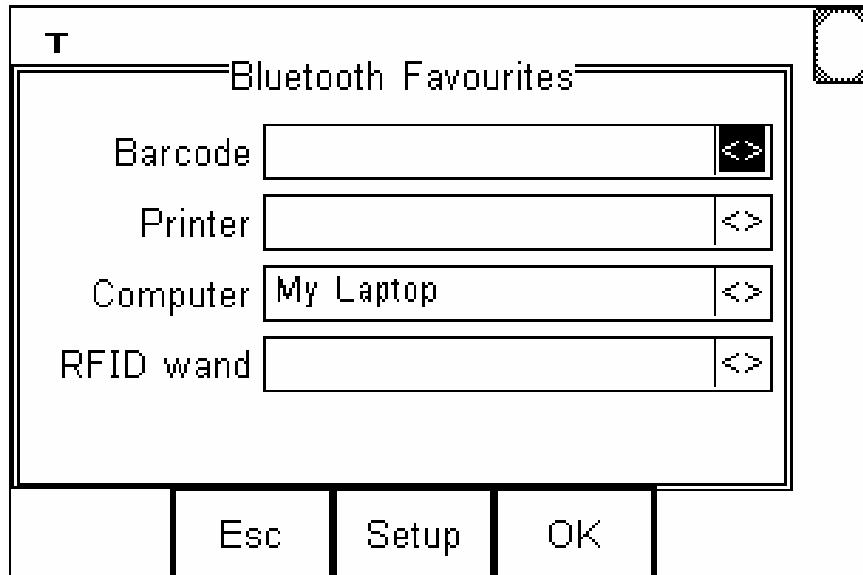

Use the up/down arrow keys to highlight the device type (in this case Printer) then press **Setup** (F3).

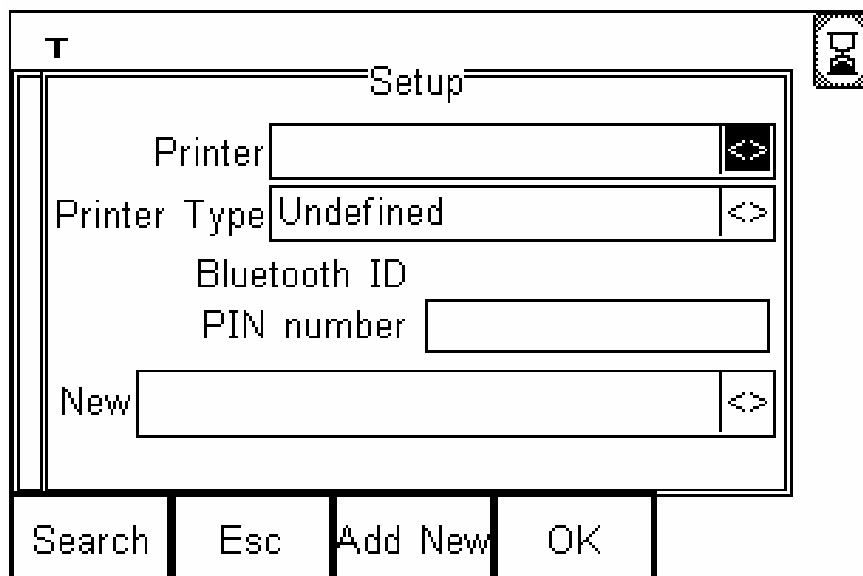

If your printer is not already in the “New” list then you need to search for it now by pressing press **Search** (F1).

Note: *If the required device is not shown, check that it is powered on with the Bluetooth function active then repeat the search.*

Use the arrow keys to highlight the required device (in this case SELPC064) and press **Select** (F4). My Laptop is now placed in the “New” field.

Now you need to specify what type of printer this device is. Use the up/down arrow keys to highlight the Printer Type, then press the Right arrow key to bring up the list of available printers.

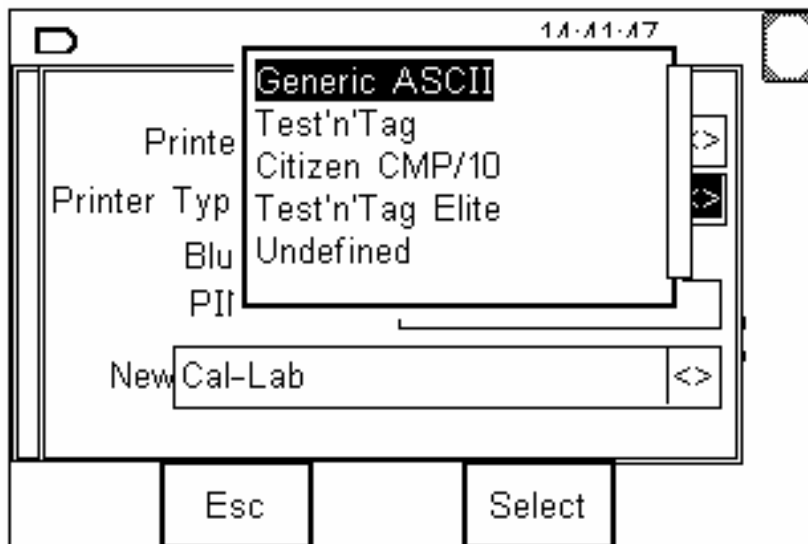

Note: *Not all the printer types show above will be in your list. The tester is undergoing continuous development and some printer types may be added or deleted as necessary .*

Highlight the correct printer type and press **Select** (F4)
Press **OK** (F4) to return to the previous screen.

If necessary, you can select another device to be set up.

When all your favourite devices have been set up, press **OK** (F4) and they will be saved.

12.4 Bluetooth Connection to a PC

When the PrimeTest 350 is required to download data to, or upload data from a PC it will automatically try to connect to the PC entered in the **Bluetooth Favourites** list (see 12.2 above). If the PC has been set up using the USB adapter supplied (see 12.1 above) a message will appear on the PC screen requesting a PIN number – enter **0000**. This should only happen the first time.

Note: *Most Bluetooth devices use the default PIN 0000.*

Each time a connection is attempted, after the first time, a message box should appear stating “Bluetooth Authorisation Request”. Click on this box then OK. This message box can be prevented if the “Always allow this device to access this service” box is ticked.

When a good Bluetooth connection is established with the PC the Bluetooth icon on the PC screen will change from white to green and the PrimeTest 350 LCD will show the Bluetooth icon in the top right corner (this is true of a successful connection to any device/accessory).

13 Automatic Test Mode

The automatic mode allows the PrimeTest 350 to perform a predefined test sequence and store the results along with details about the equipment under test.

To perform an Auto Test press the **Menu** (F4) key to open the menu.

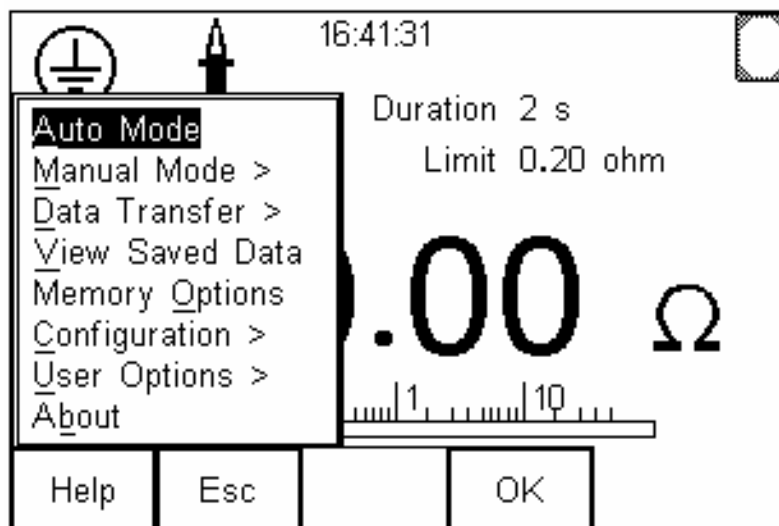

The **Auto Mode** is highlighted. Press **OK** (F4) or right arrow to open the **Asset Details** screen.

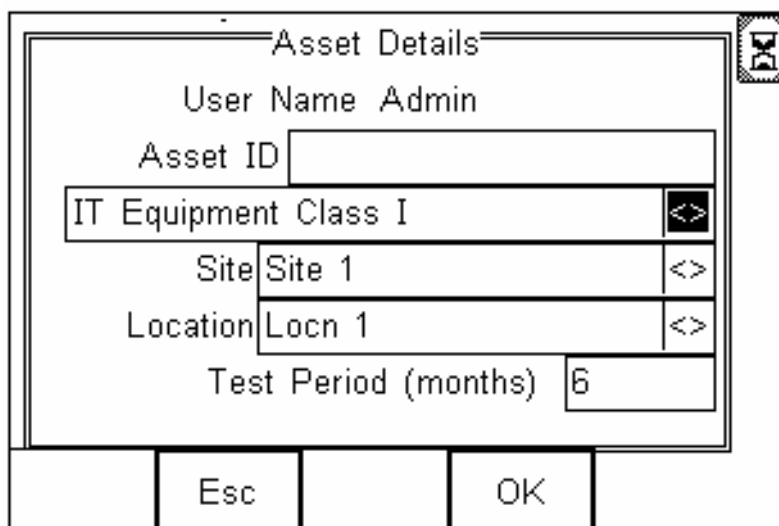

13.1 Entering an Asset ID

If the PrimeTest 350 has been configured to accept data entry from a barcode scanner, the tester will now search for the barcode scanner in **Bluetooth Favourites**.

Whilst searching, the Bluetooth status icon shows an egg timer in the top right hand corner of the display.

Note: If the egg timer does not appear check that the PrimeTest 350 has been configured to accept data entry from a barcode scanner. Menu (F4), User Options, Preferences, Data Entry should be set to Barcode.

When a connection to the barcode scanner is established the status icon changes to the Bluetooth icon.

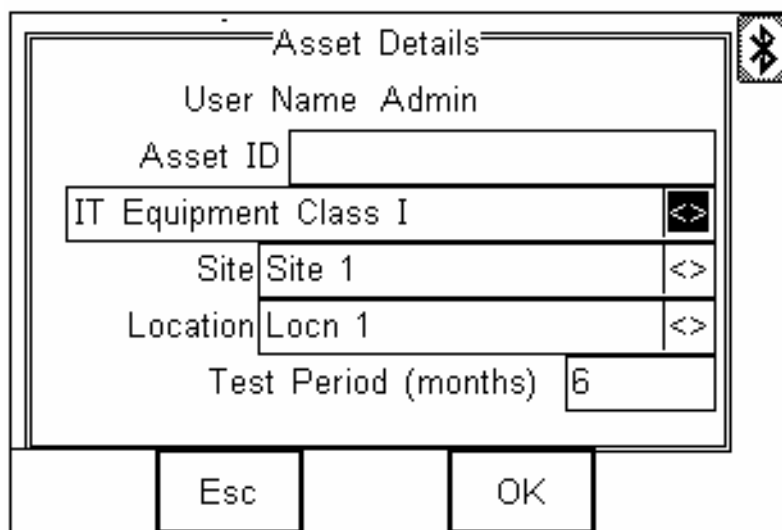

The screenshot shows the 'Asset Details' screen on the PrimeTest 350. The screen displays the following information:

- User Name: Admin
- Asset ID: (empty field)
- IT Equipment Class: I (dropdown menu)
- Site: Site 1 (dropdown menu)
- Location: Locn 1 (dropdown menu)
- Test Period (months): 6

The Bluetooth status icon is visible in the top right corner of the display. At the bottom of the screen, there are buttons for 'Esc' and 'OK'.

An **Asset ID** can be entered by scanning the ID using a barcode scanner as shown below.

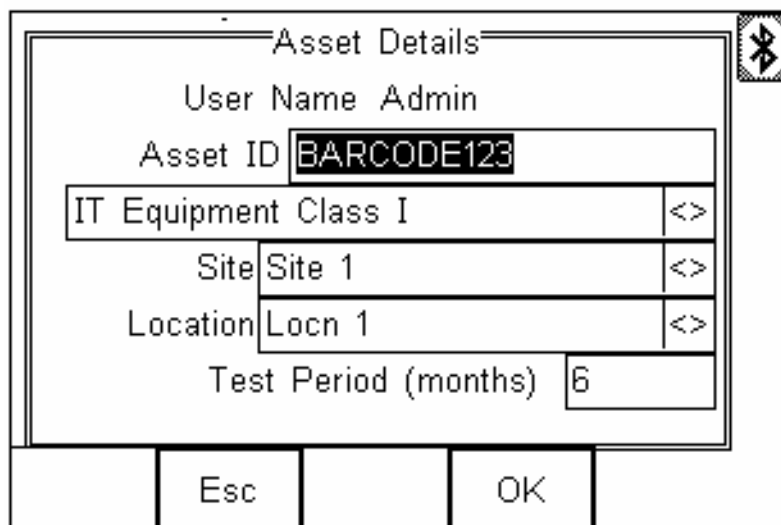

The screenshot shows the 'Asset Details' screen on the PrimeTest 350. The screen displays the following information:

- User Name: Admin
- Asset ID: BARCODE123
- IT Equipment Class: I (dropdown menu)
- Site: Site 1 (dropdown menu)
- Location: Locn 1 (dropdown menu)
- Test Period (months): 6

The Bluetooth status icon is visible in the top right corner of the display. At the bottom of the screen, there are buttons for 'Esc' and 'OK'.

Alternatively, the **Asset ID** can be entered using the

keypad. Simply enter the required ID in the Asset ID field as shown below. The function keys can be used to edit the entry.

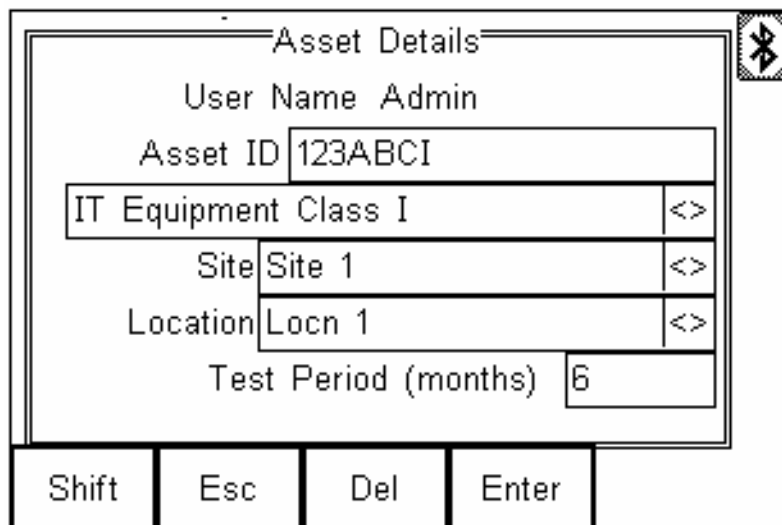

The screenshot shows a terminal window titled "Asset Details" with a Bluetooth icon in the top right corner. The form contains the following fields and values:

User Name	Admin
Asset ID	123ABCI
IT Equipment Class	I
Site	Site 1
Location	Locn 1
Test Period (months)	6

At the bottom of the window are four buttons: Shift, Esc, Del, and Enter.

When the required ID is shown in the **Asset ID** field press the **Enter** (F4) key to accept. The **Asset ID** will now be highlighted as shown below.

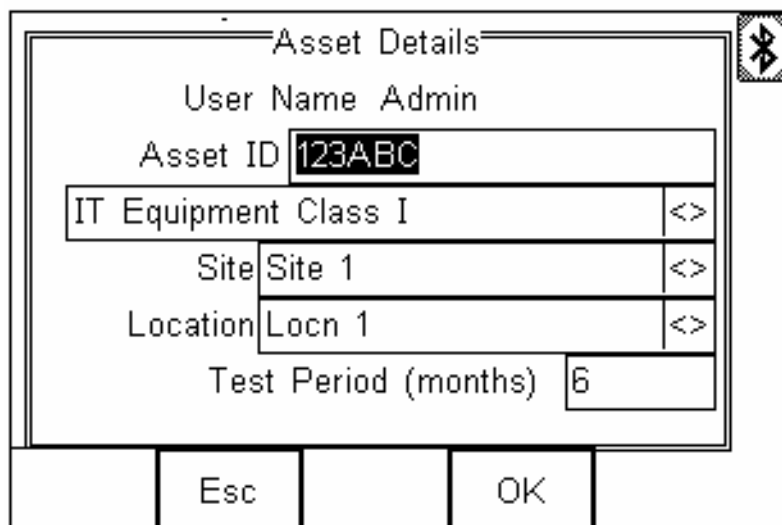

The screenshot shows the same "Asset Details" terminal window. The "Asset ID" field now contains "123ABC" and is highlighted with a black background. The other fields remain the same:

User Name	Admin
Asset ID	123ABC
IT Equipment Class	I
Site	Site 1
Location	Locn 1
Test Period (months)	6

At the bottom of the window are two buttons: Esc and OK.

13.2 Entering Site Information

Using the arrows, move the cursor to highlight the **Site** field as shown below.

13.2.1 Seaward Quick Text

The PrimeTest 350 is equipped with Seaward Quick Text to greatly reduce the time taken to enter Site,

Location and Comments data.

When a character is entered using the keypad, the PrimeTest 350 will automatically list any appropriate data currently in memory that begins with the character that is entered.

The screenshot shows the 'Asset Details' screen on the PrimeTest 350. The fields are as follows:

User Name	Admin
Asset ID	123ABC
IT Equipment Class	I
Site	Site 1
Location	Locn 1
Test Period (months)	6

At the bottom of the screen, there are two buttons: 'Esc' and 'OK'. A Bluetooth icon is visible in the top right corner of the screen.

A **Site** can be chosen from the list current stored in the PrimeTest 350 or a New Site can be entered using the keyboard.

Note: *Section 6.2.1 gives details on how to transfer Site lists from a PC.*

13.2.2 Selecting a Site using Quick Text

Simply enter the first letter of the required **Site** name using the keypad. If the **Site** name is currently in the PrimeTest 350 memory it will be displayed in a list of available **Sites**. The example below shows the display if the "N" key is pressed on a PrimeTest 350 that has been pre-configured with a list of **Sites**.

Asset Details

User NEWCASTLE

Asset ID NOTTINGHAM

IT Equipme

Site NI

Location Locn 1

Test Period (months) 6

Shift Esc Del Enter

The UP/DOWN can now be used to scroll through the Site list until the required **Site** is highlighted.

Asset Details

User **NEWCASTLE**

Asset ID NOTTINGHAM

IT Equipme

Site NEWCASTLE

Location Locn 1

Test Period (months) 6

Esc Select

Press Select (F4) to confirm selection

Asset Details

User Name Admin

Asset ID 123ABC

IT Equipment Class I

Site **NEWCASTLE**

Location Locn 1

Test Period (months) 6

Esc OK

Note: To see a list of all Sites currently stored in the PrimeTest 350 memory, simply press the left of right arrow key when the Site field is highlighted.

Quick Text can then be used to find specific a specific Site or you can simply scroll through the list using the up and down arrow keys.

13.1.2 Adding a new Site

If the required **Site** is not already in memory, simply use the keypad to enter the new **Site** name.

The Edit keys can be used to correct the entry.

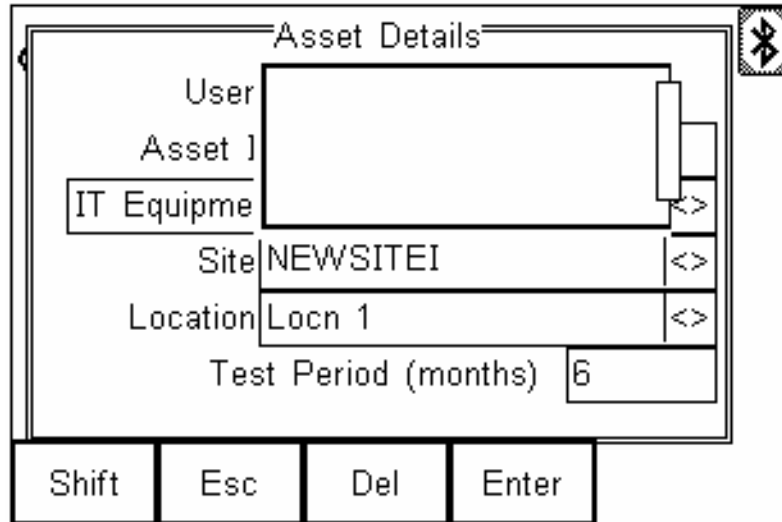

The screenshot shows the 'Asset Details' screen with the following fields and values:

User	
Asset ID	
IT Equipme	
Site	NEWSITEI
Location	Locn 1
Test Period (months)	6

At the bottom of the screen, there are four buttons: Shift, Esc, Del, and Enter.

When the required data has been entered, press the **Enter** (F4) key to accept.

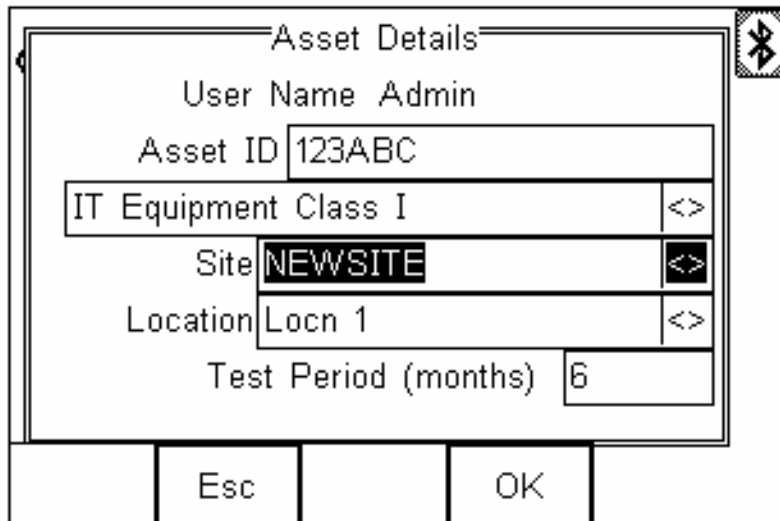

The screenshot shows the 'Asset Details' screen with the following fields and values:

User Name	Admin
Asset ID	123ABC
IT Equipment Class	I
Site	NEWSITE
Location	Locn 1
Test Period (months)	6

At the bottom of the screen, there are two buttons: Esc and OK.

Note: *Once a Site name is entered, it is added to the list of available sites for future use.*

13.3 Entering Location Information

Move the cursor to the Location field.

The screenshot shows the 'Asset Details' screen on a PrimeTest 350. The screen displays the following information:

- User Name: Admin
- Asset ID: 123ABC
- IT Equipment Class: I
- Site: NEWSITE
- Location: Locn 1
- Test Period (months): 6

The Location field is highlighted with a black background. Below the screen are buttons for 'Esc' and 'OK'.

A **Location** can be selected in the same way as a **Site**, using Quick Text to choose from the list previously stored in memory or a new **Location** can be entered using the keypad.

Note: *If the LEFT/RIGHT arrows are pressed before entering a character from the keypad, the full Location list will be opened.*

13.3.1 Selecting Location using Quick Text

Enter the first letter of the required **Location** name using the keypad. If the **Location** name is currently in memory it will be displayed in a list of available **Locations**. The example below shows the display if the "S" key is pressed on a PrimeTest 350 that has been pre-configured with a list of **Locations**.

Asset Details

User SALES

Asset I SERVICE

IT Equipme SECOND FLOOR

Site

Location SI

Test Period (months) 6

Shift Esc Del Enter

Select the desired **Location** from the list using the UP/DOWN arrows and press **Select** (F4) to confirm.

Asset Details

User SALES

Asset I SERVICE

IT Equipme SECOND FLOOR

Site

Location SALES

Test Period (months) 6

Esc Select

Note: *Section 6.2.1 gives details on how to transfer Location lists from a PC to the PrimeTest 350 memory.*

13.3.2 Adding a new Location

If the required **Location** is not already in memory, simply use the keypad to enter the new **Location** name.

Asset Details

User

Asset ID

IT Equipment Class

Site

Location NEW LOONI

Test Period (months) 6

Shift Esc Del Enter

The Edit keys can be used to correct the entry.

When the required data has been entered, press the **Enter** (F4) key to accept.

Asset Details

User Name Admin

Asset ID 123ABC

IT Equipment Class I

Site NEWCASTLE

Location NEW LOON

Test Period (months) 6

Esc OK

13.4 Selecting a Test Sequence

The test sequence is the set of tests that will be performed on the Asset. The PrimeTest 350 contains a number of pre-programmed sequences for a variety of electrical equipment.

Move the cursor to highlight the test sequence field as shown.

Asset Details

User Name Admin

Asset ID 123ABC

IT Equipment Class I

Site NEWCASTLE

Location NEW LOCN

Test Period (months) 6

Esc OK

Pressing the Left or Right arrows will open the list of available test sequences

A) 230V HandHeld/Portable Cl.I

B) 230V HandHeld/Portable Cl.II

C) IT Equipment Class I

D) IT Equipment Class II

E) 230V Movable/Stationary Cl.I

F) 230V Movable/Stationary Cl.II

Test Period (months) 6

Esc Select

Press the index letter next to the required test sequence name or use the **UP/DOWN** arrows to navigate through the list. When the required test sequence is highlighted, pressing **Select (F4)** or pressing the **LEFT/RIGHT** arrows will select the highlighted sequence.

13.5 Frequency of inspection

The **Test Period** is the frequency, in months, of inspection and testing of the equipment.

Note: *Suggested values can be found in the IEE Code of Practise for In-Service Inspection and Testing of Electrical Equipment.*

To enter a value, simply move the cursor to the correct field using the **UP/DOWN** arrows

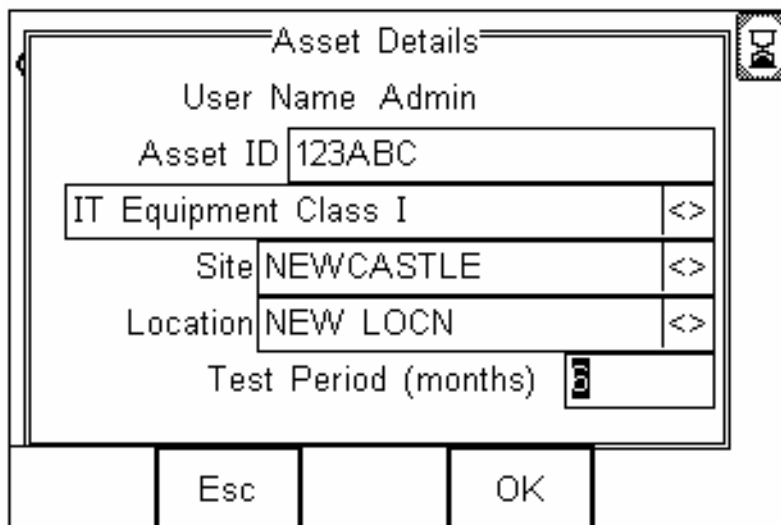

The screenshot shows a terminal window titled "Asset Details" with a cursor icon in the top right corner. The form contains the following fields and values:

User Name	Admin
Asset ID	123ABC
IT Equipment Class	I
Site	NEWCASTLE
Location	NEW LOCN
Test Period (months)	

At the bottom of the window, there are four buttons: "Esc", a blank button, "OK", and another blank button.

Now enter the required number of months and press **Enter** (F4) to accept.

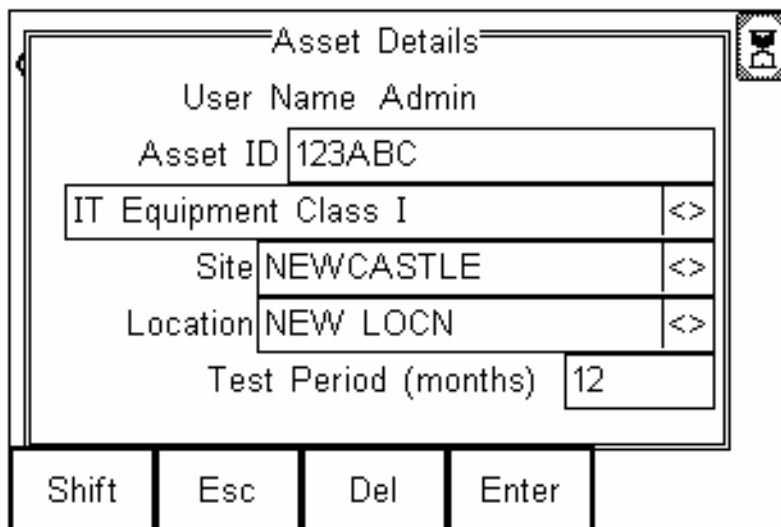

The screenshot shows the same "Asset Details" terminal window. The "Test Period (months)" field now contains the value "12". The cursor is positioned at the end of this field. The buttons at the bottom are now "Shift", "Esc", "Del", and "Enter".

The **Asset Details** are now complete and the PrimeTest 350 is ready to perform the test.

13.6 Running the test sequence

When the required Asset ID, Site, Location and Test Period details have been entered, press the **OK** (F4) key to initiate the test sequence.

Asset Details

User Name Admin

Asset ID 123ABC

230V HandHeld/Portable Cl.I

Site NEWCASTLE

Location NEW LOCN

Test Period (months) 12

Esc OK

If the red STOP key is pressed during a test then the test is aborted and the abort menu appears as shown below:

Restart Test

Restart Appliance

Abort Test

Abort Appliance

Restart Test will return to the beginning of the test that was aborted.

Restart Appliance will return to the beginning of the test sequence.

Abort Test will skip the test that was aborted and proceed to the next test in the sequence.

Abort Appliance will abort the test sequence.

The first test in this sequence is a visual inspection. The default Visual Test consists of a three-point inspection of the appliance cord, power lead and fuse. After performing the inspection, the appropriate PASS/FAIL results are entered using the function keys **Pass** (F3), **Fail** (F1) or **N/A** (F2). Function key **Pass All** (F4) allows a PASS result to be entered for all points of the inspection.

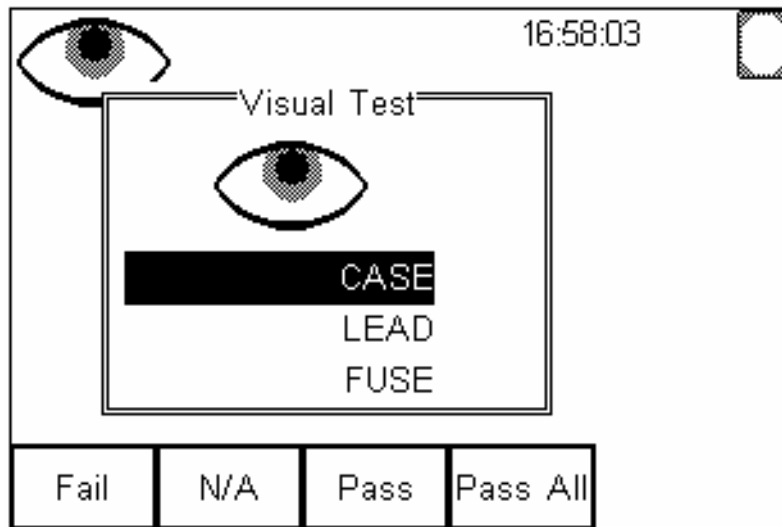

The sequence will now progress to the Earth Continuity test as shown. This test will measure the resistance of the protective earth path.

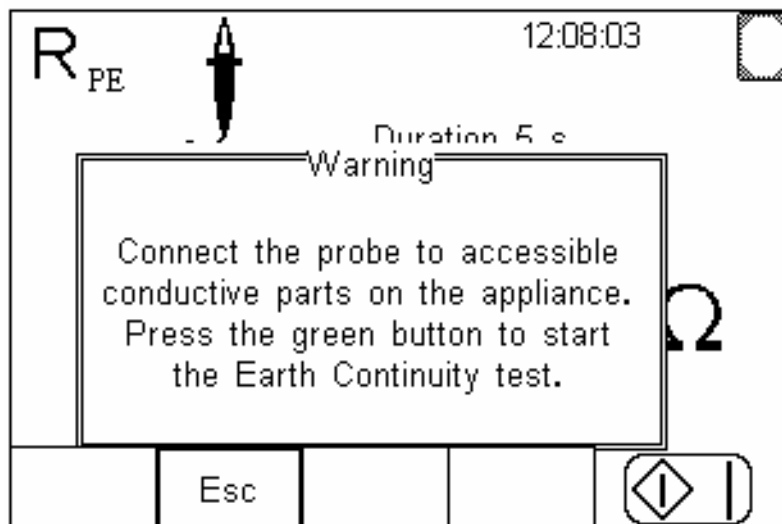

The **START** key icon is flashing, indicating that a key press is required to initiate the test. The probe icon is illuminated to indicate that the test probe is required for this test. Connect the test probe to an exposed metal part on the equipment under test and press the **START** key to begin measurement.

Real time measurement values are displayed whilst the test is in progress.

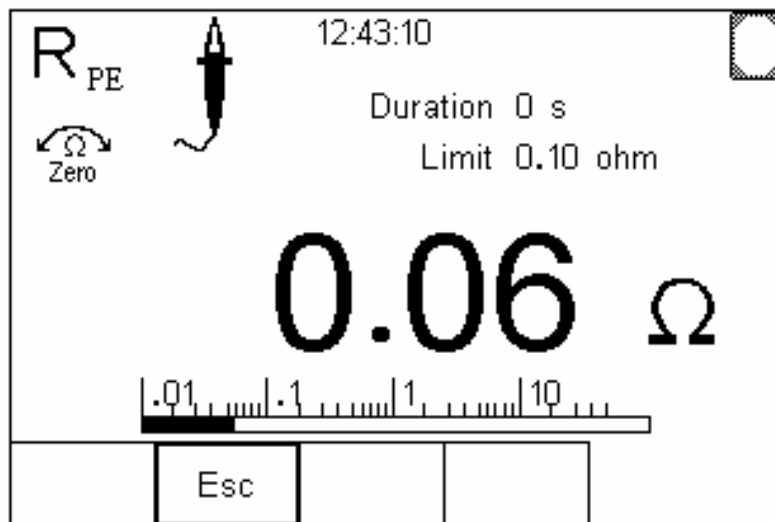

The test will run until the countdown timer in the Duration field has reached zero.

Note: During the test, the mains cord should be flexed at the points of entry into the equipment and the mains plug. Changes in the reading may indicate damage to the protective earth conductor or a poor connection.

At the end of the test duration, the PrimeTest 350 will compare the last reading with the Limit to determine the outcome of the test. If the last reading is lower than the Limit, a Pass result is recorded. This is indicated on the display by a large tick mark next to the measurement field, as shown below.

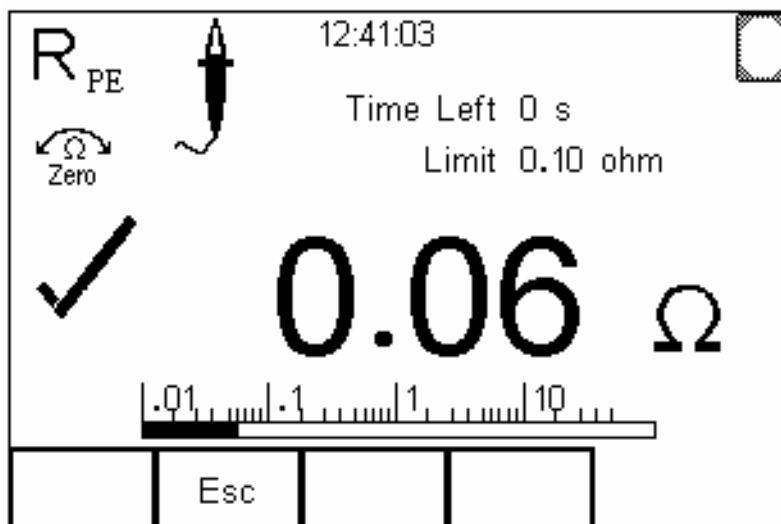

Similarly, if the last reading is greater than the Limit, a Fail result is recorded. This is indicated by a large cross next to the measurement field as shown below.

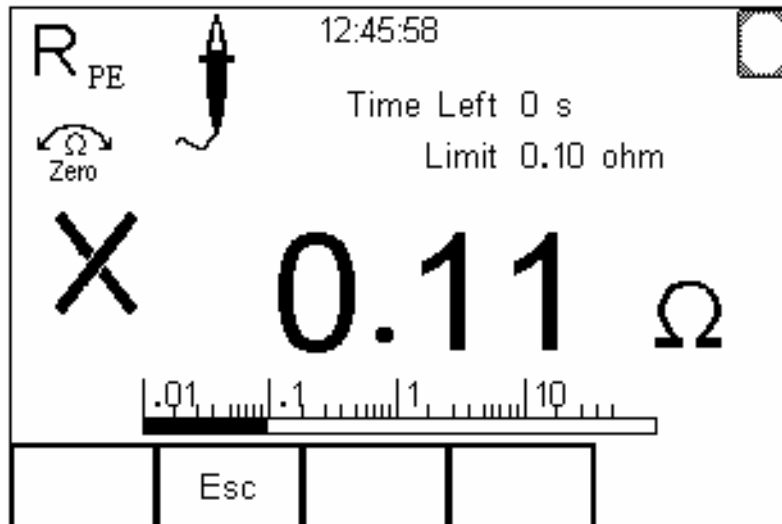

If the Earth Continuity test results in a Fail and the **On Test Failure** is set to **End Test** the sequence is terminated.

Note: On Test Failure is set in User Options – Test Options – On Test Failure.

If the Earth Continuity test results in a Fail and the **On Test Failure** is set to **Fail Menu** the display is as shown below.

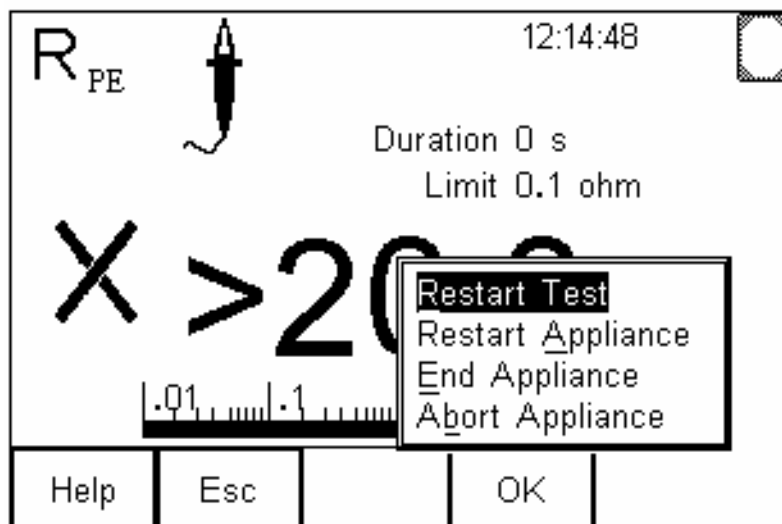

The earth continuity test can be restarted by simply pressing **OK** (F4) to select Restart Test.

The next test in the sequence for 230V Hand Held or Portable Class I is an insulation resistance test. The display is as shown below.

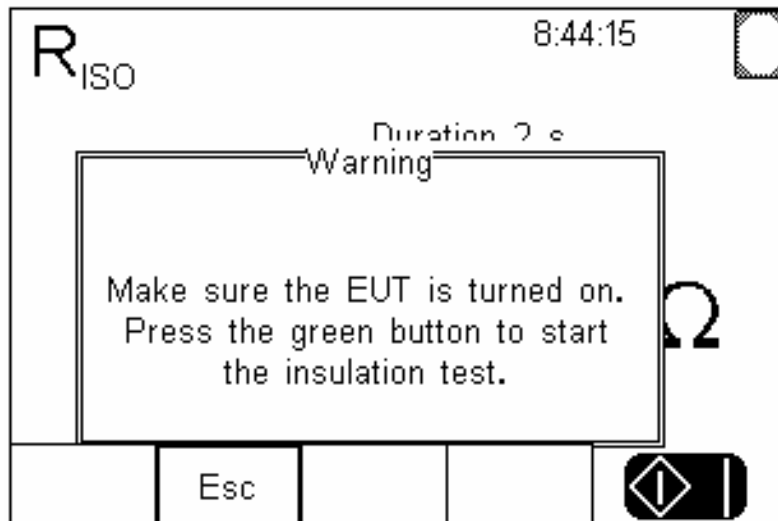

Note: *In order to perform an Insulation Resistance measurement correctly, the EUT mains switch must be in the ON position. If the EUT mains switch is OFF, only the insulation of the power cord will be tested, as the test voltage cannot be applied beyond the mains switch.*

When satisfied that the EUT mains switch is in the ON position, press the **START** key to proceed. The display will now progress to the measurement screen as shown below.

Note: *In Expert Mode the test will begin with the on screen prompt and START key press.*

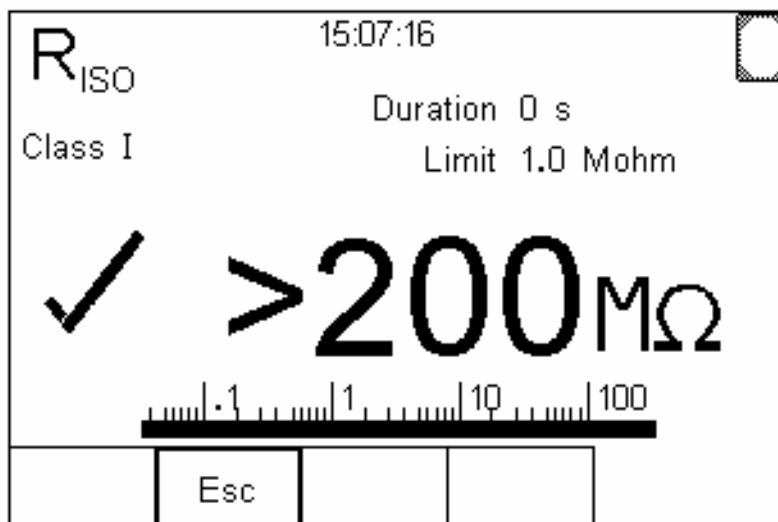

The Class I icon is illuminated to indicate that the insulation resistance is measured between the live/neutral conductors and the protective earth.

Note: The probe icon is turned off as the test probe is not required for Class I insulation resistance measurements.

The display shows that the measured value is $>200\text{M}\Omega$. This is greater than the Limit of 1.0 Mohm hence the tick mark is shown to indicate a Pass result.

Next in the sequence is the Protective Conductor Current measurement. This is now the preferred term for what used to be referred to as Earth Leakage.

Note: Mains power is applied to the EUT for this test and hence the mains must be connected to the PrimeTest 350.

The PrimeTest 350 will check for the presence of correct supply before starting a powered test. If there supply is not present the message shown below is displayed.

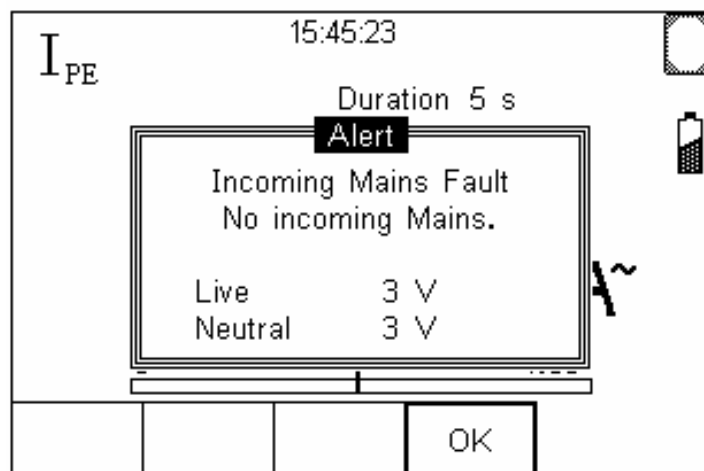

Connect a mains supply to the PrimeTest 350 and press OK to proceed.

Note: The appliance will be powered during this test. Make sure it is safe to proceed, particularly when testing an appliance with moving or rotating parts, before pressing the START key.

The sequence will now progress to the Protective Conductor Current measurement.

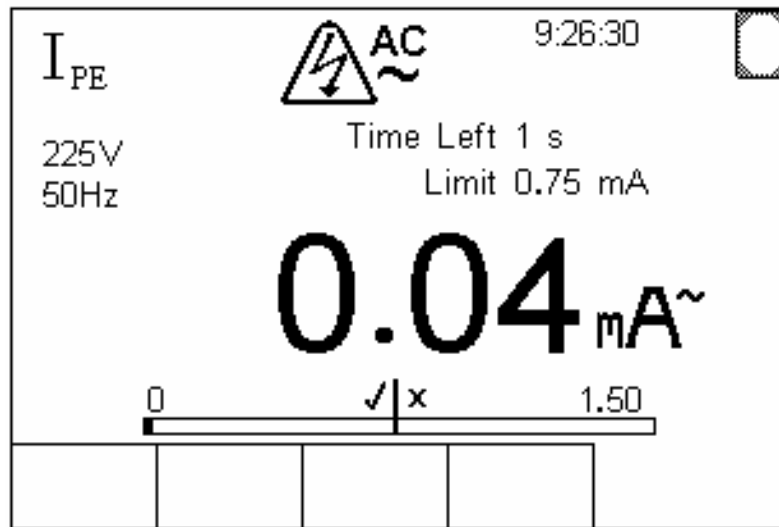

The display now shows the supply voltage and frequency measured prior to starting the test. The measured protective conductor current is shown in real time on both the digital display and the analogue bargraph.

Note: The vertical bar midway along the analogue bargraph indicates the Limit value (in this case 0.75mA).

The test sequence is now complete. The display at the end of a sequence depends upon the options set in **Menu – User Options – Test Options** as described in section 10.1.3.

The example below shows the end of test screen when **Menu – User Options – Test Options** has been configured for **Options Menu**.

Test Details			
Asset ID	123ABC		
Site	NEWTOWN		
Location	WORKSHOP		
Tested by	Admin		
Tested on	15 Dec 2005 15:08		
Status	Pass	Test Type	FULL
Test Period (months)	12		
New Test		Options	

The **Test Type** field indicates whether the sequence was a visual inspection only or measured values were recorded during the test sequence. Test sequences that do not involve the recording of measured values have the Test Type is set to Visual.

13.7 Options

Pressing **Options** (F3) offers a list of post-test options as shown below.

Test Details								
Asset ID	A000032							
Site	Site 1							
Location	Locn 1							
Tested on	:06							
Status	Fail	Test Type	FULL					
Test Period (months)	6							
<table border="1"> <tr> <td>View Results</td> </tr> <tr> <td>Information</td> </tr> <tr> <td>Print Label</td> </tr> <tr> <td>Print Result</td> </tr> <tr> <td>Write RFID Tag</td> </tr> </table>				View Results	Information	Print Label	Print Result	Write RFID Tag
View Results								
Information								
Print Label								
Print Result								
Write RFID Tag								
Help	Esc		OK					

This allows the user to view the results of each test in the sequence, view information about the EUT, print a test label, print the test results, or write the results to an RFID tag.

13.7.1 View Results

This will display the results for each test in the sequence as shown below.

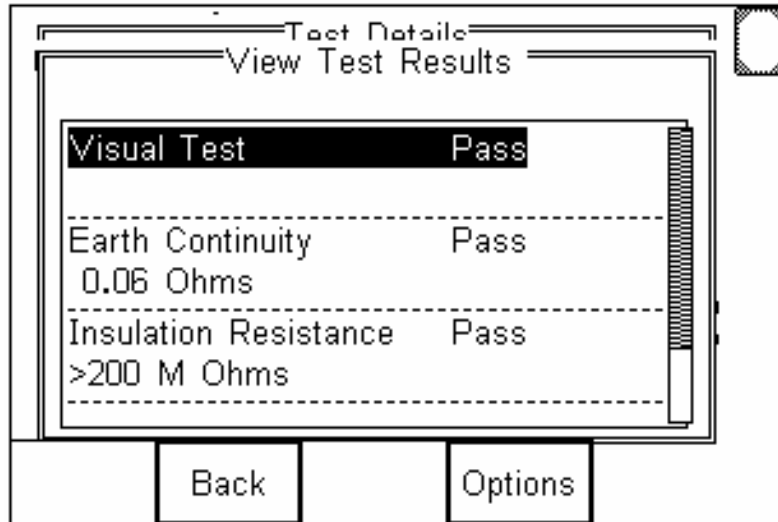

The Up and Down arrows can be used to scroll through the test results. The scroll bar on the right hand side of the display shows the position of the results in the display window.

13.7.2 Information

This will display the asset description and comment as shown below.

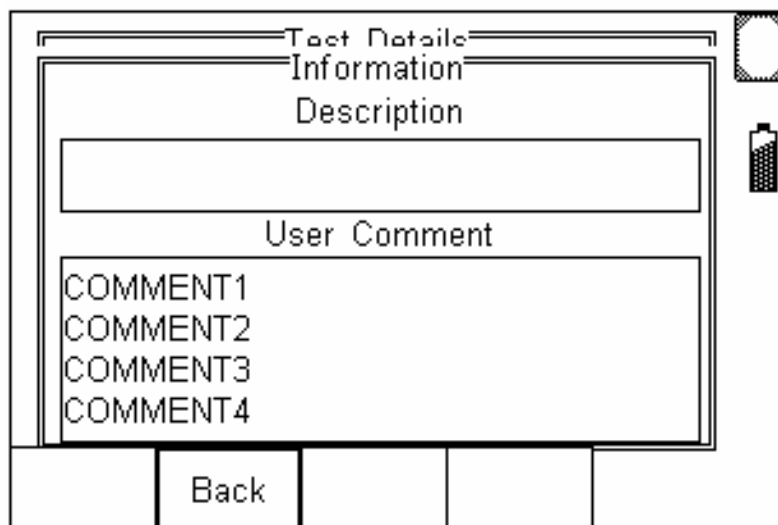

Note: Asset Description is entered using the Upload facility on Seaward PATGuard Plus

13.7.3 Print Label

This allows Pass/Fail labels to be printed using the printer in the Bluetooth Favourites list.

When selected, the image that will be transferred to the label will be shown on the display.



A number of pre-configured label formats are available. Pressing **Change Format** (F1) will cycle through the available formats. The number of formats will depend on the type of printer. Notes on each printer type can be found in section 14 (Printer Driver Specifications).

13.7.4 Print Result

This allows test results to be printed using the printer in the Bluetooth Favourites list.

Note: To print results the printer must be fitted with a paper roll.

13.7.5 Write RFID Tag

This is used to write test records to Seaward RFID brain cells. Refer to Seaward Braincell wand operating instructions for details on how to use this feature.

14 Printer Driver Specifications

14.1.1 Test n Tag Elite

The screenshot shows the 'Test'n'Tag Elite' printer driver interface. At the top, it displays 'Asset ID' followed by a barcode and the number 'A000001'. Below the barcode is a table with the following data:

Last Test	17 Aug 2007
Retest	17 Feb 2008
Tested by	Admin
Status	Pass

At the bottom of the interface, there are four buttons: 'Change Format', 'Esc', 'Setup', and 'Please wait...'.

Note: *The maximum number of characters that can be displayed on the Test n Tag Elite barcode is 11.*

If this limit is exceeded, the barcode will not appear on the display and will not be printed on the label.

A number of pre-configured label formats are available. Pressing **Change Format** (F1) will cycle through the available formats.

The appearance of the Test 'n' Tag Elite labels can be altered by pressing **Setup** (F3).

The screenshot shows the 'Test'n'Tag Elite Setup' printer driver interface. At the top, it displays 'PrimeTest Test'n'Tag Label'. Below this, there are several configuration options:

- Pass Logo: User Defined Logo <>
- Fail Logo: No <>
- Print Density: 1
- Printer: XXRD06-50-5022 <>

At the bottom of the interface, there are two buttons: 'Esc' and 'OK'.

Note: In order to avoid damage to the print head, only genuine Seaward Test 'n' Tag Elite labels should be used.

Use of incorrect labels will damage the print head and invalidate the printer warranty.

A different logo can be specified for assets that have failed the safety tests.

14.1.2 Citizen CMP-10BT



Note: *The maximum number of characters that can be displayed on a CMP-10 barcode is 12.*

If this limit is exceeded, the barcode will not appear on the display and will not be printed on the label.

The default printer header, "Safety Tested" can be modified if required. To change the print header, press **Setup** (F3), enter the required text in the highlighted field and press **OK** (F4) to accept.

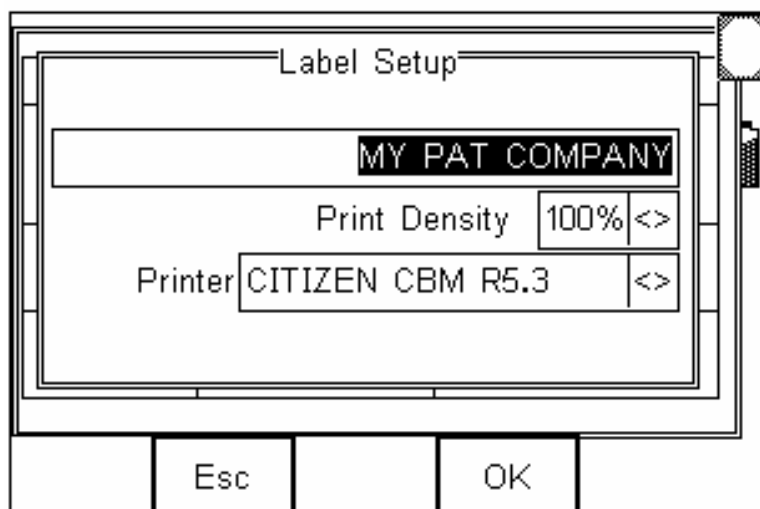

Note: *To print labels, the printer must be fitted with Seaward thermal labels.*

14.1.3 Test n Tag

This allows Test 'n' Tag labels to be produced using the Seaward Test 'n' Tag thermal transfer print system.

When selected, the image that will be transferred to the Test 'n' Tag label will be shown on the display.

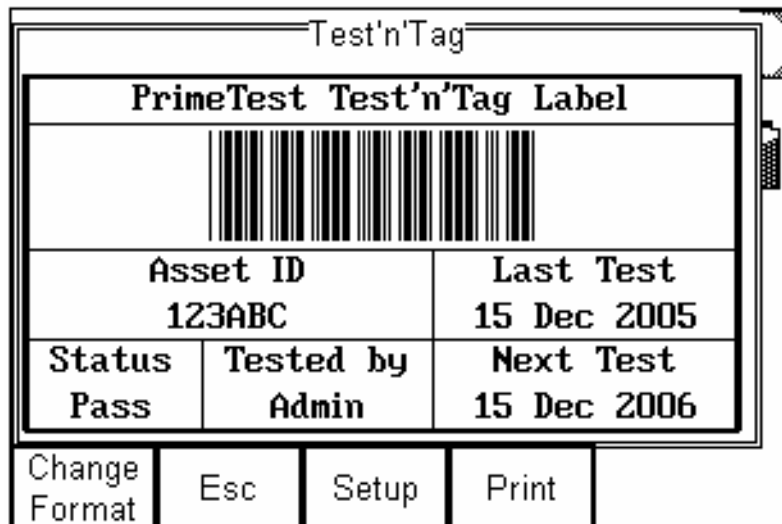

Note: *The maximum number of characters that can be displayed in a Test 'n' Tag barcode is 12.*

If this limit is exceeded, the barcode will not appear on the display and will not be printed on the label.

A number of pre-configured label formats are available. Pressing **Change Format** (F1) will cycle through the available formats.

The appearance of the Test 'n' Tag labels can be altered by pressing **Setup** (F3).

Test'n'Tag	
Test'n'Tag Setup	
PrimeTest Test'n'Tag Label	
User Defined Logo	Yes <>
Pre Feed	0.25
Post Feed	1.50
Print Density	3
Label Size	User Defined <>
Printer	SELPC033 <>
Esc OK	

The text in the banner line can be edited to show up to 29 chosen characters.

The default Pre Feed and Post Feed values are 0.25" and 1.50" respectively. You can change these values as necessary, or simply use the "Label Size" field to select "Cable Wrap / Panel" which will give preferred values.

14.1.4 Generic ASCII

This printer driver uses only standard ASCII characters and so can be used with almost any Bluetooth printer. It can also be used to capture data to a PC, in which case you should use Bluetooth Favourites to set up a Generic ASCII Printer which has the Bluetooth address of your PC. Then when you print, the PrimeTest 350 will connect to your PC and the print data can be captured using **DataTransfer.exe** or **HyperTerminal**.

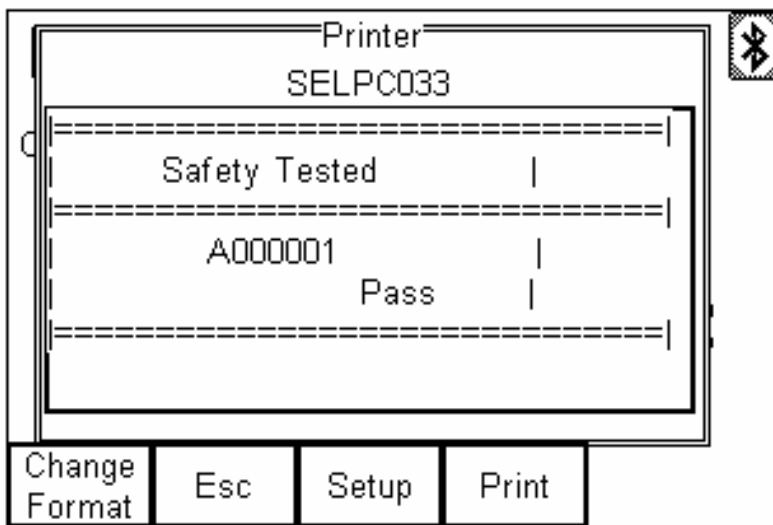

Note: Barcodes cannot be printed by the Generic ASCII driver..

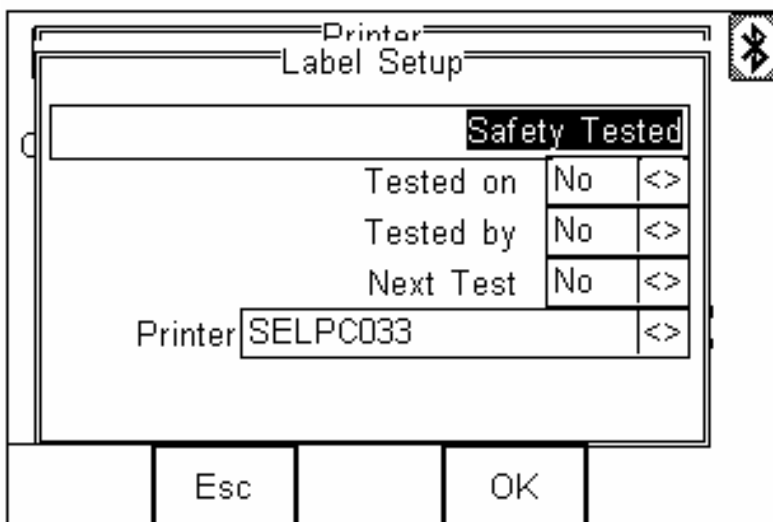

15 Electrical Specifications

15.1 Earth Continuity

Test Current (2 Ω load)	± 200 mA
Test Circuit Voltage	± 4 V min
Test Duration	2, 5, 10, 20, 30 seconds
Pass/Fail Limit	User Defined
Display Range	0.00 – 19.99 Ω
Measuring Range	0.01 – 19.99 Ω
Resolution	0.01 Ω
Accuracy	$\pm 5\%$ ± 2 digits

15.2 Insulation Resistance

Test Voltage Open Circuit	250V or 500V +20% / -0%
Test Voltage @ 1mA	250V or 500V min
Test Current Short Circuit	<2 mA
Test Duration	2, 5, 10, 20, 30 seconds
Pass/Fail Limit	User Defined
Display Ranges	0.00 – 1.99M Ω 2.0 – 19.9M Ω 20 – 199M Ω
Measuring Range	0.01 – 40M Ω
Resolution	0.01M Ω , 0.00 – 1.99M Ω 0.1M Ω , 2.0 – 19.9M Ω 1M Ω , 20 – 199M Ω
Accuracy	$\pm 5\%$ ± 2 digits

15.3 Substitute Leakage

Test Voltage	40V a.c 50Hz open circuit
Test Duration	2s – 30s
Pass/Fail Limit	User Defined
Display Range	0.15 – 19.99mA
Measuring Range	0.25 – 19.99mA
Resolution	0.01mA
Accuracy	$\pm 5\%$ ± 2 digits

Note: *The displayed measurements can be scaled for a supply voltage of 230 V, 244 V or 253 V depending on configuration(i.e. 230 + 0 %, +6% or +10%).*

15.4 Protective Earth Conductor Current

Measurement Method	Differential
Test Voltage	Mains supply 230V +10% / -15%
Max Load Current	16A
Test Duration	2, 5, 10, 20, 30 seconds
Pass/Fail Limit	User Defined
Display Range	0.00 – 19.99mA
Measuring Range	0.25 – 19.99mA
Resolution	0.01mA
Accuracy	± 10% ±2 digits

 **Attention: Avoid prolonged, repeated use at full load (16A) and excessive test duration as this may reduce the life of the unit.**

15.5 Touch Current

Test Voltage	Mains supply 230V +10% / -15%
Max Load Current	16A
Input Impedance	2KΩ As per IEC 61010-1 A.1
Test Duration	2, 5, 10, 20, 30 seconds
Pass/Fail Limit	User Defined
Display Range	0.00 – 3.50mA
Measuring Range	0.10 – 3.50mA
Resolution	0.01mA
Accuracy	± 10% ±2 digits

 **Attention: Avoid prolonged, repeated use at full load (16A) and excessive test duration as this may reduce the life of the unit.**

15.6 Voltage/Frequency Measurement

Incoming mains voltage and frequency are displayed during the 2 powered tests only.

Voltage Display Range	0 – 300V
Voltage Measuring Range	20 – 300V
Voltage Resolution	1V
Voltage Accuracy	± 10%
Frequency Measuring Range	50Hz or 60Hz
Frequency Accuracy	Indication only

15.7 Load Measurement

Load current is measured during the 2 powered tests only. The load in kVA is calculated from incoming mains voltage and the load current.

Load Display Range	0 – 4.00kVA
Load Resolution	0.01kVA
Load Accuracy	± 10% ±5 digits

15.8 Earth Loop Resistance

Test Voltage	Mains supply 230V +10% / -15%
Test Current	Non-trip for 30mA RCD
Test Duration	Approx 10 seconds
Pass/Fail Limit	User Defined
Display Ranges	0.0 – 199Ω
Measuring Range	1.0 – 199Ω
Resolution	0.1Ω, 0.0 – 19.9Ω 1Ω, 20 – 199Ω
Accuracy	± 10% ±2 digits

15.9 RCD Trip Time

Test Voltage	Mains supply 230V +10% / -15%
Test Current	30mA rms sinusoidal
Test Duration	2000ms max
Pass/Fail Limit	None
Display Range	0 – 2000ms
Measuring Range	20 – 2000ms
Resolution	1ms
Accuracy	± 10%

15.10 IEC Lead Test

This is a 3 part test is made up of:

Earth Continuity – specification as 10.1 above.

Insulation Resistance – specification as 10.2 above.

Wiring Check – checks for:

- Live open
- Neutral open
- L/N Short
- L/N Reversed

16 Environmental Conditions

- 16.1 The PrimeTest 350 has been designed to perform tests and measurements in a dry environment.
- 16.2 Maximum barometric elevation for making measurements is 2000M.
- 16.3 Overvoltage category IEC 60664/IEC 61010, 300V Category II.
- 16.4 Pollution degree 2 according to IEC 61010-1.
- 16.5 Protective system IP40 according to IEC 60529.
- 16.6 Electromagnetic compatibility (EMC). Interference immunity and emitted interference conforming to IEC 61326-1.
- 16.7 Operating temperature range of 0°C to 40°C, without moisture condensation.
- 16.8 The PrimeTest 350 can be stored at any temperature in the range -25°C to +65°C (relative humidity up to 90%). The batteries should be taken out of the instrument for storage.

17 Maintenance



Warning: Always ensure that the PrimeTest 350 is disconnected from all voltage sources before maintenance work is carried out.

17.1 Preparing to work on the PrimeTest 350.

Make the PrimeTest 350 voltage free as follows, before opening the instrument;

Power the unit off using the red OFF button, ref fig. 1 (3)

Disconnect the black test lead from the unit

Disconnect the Seaward mains cable, from the mains inlet socket, ref fig 2 (7).

Disconnect the IEC mains cable, from the IEC socket ref fig 2 (8).

Disconnect the EUT mains cable, from the EUT socket, ref fig 1 (6).

17.2 Securing the PrimeTest 350

Under certain conditions safe operation of the PrimeTest 350 can no longer be assumed:

Visible damage of the instrument case.

Incorrect measurement results.

Recognisable abuse to the instrument due to prolonged storage under improper conditions.

Recognisable abuse to the instrument due to extraordinary transportation stress.

In these cases, the PrimeTest 350 should be immediately switched off, disconnected from any test or measurement function and secured to prevent any further use.

17.3 Cleaning

Clean the external case of the PrimeTest 350 with a clean dry cloth.

Avoid using solvents and abrasive scouring agents to clean the external case of the PrimeTest 350.

Check the battery contacts and compartment are free of electrolytic contamination.

Any contamination of the battery contacts or compartment should be cleaned with a dry cloth.

17.4 Battery Charging



Never attempt to recharge non-rechargeable cells in the PrimeTest 350. Always check that the correct NiMH batteries are fitted before connecting the charger.



Only use the Seaward PT- 01 charger to charge the batteries in the PrimeTest 350.

The PrimeTest 350 is supplied with re-chargeable NiMH batteries.

Power the unit off using the red OFF button, ref fig. 1 (3)

Connect the battery charger to the mains. Once the charger is connected to mains it is ready for use.

Connect the battery charger to the charger input socket, ref fig. 2 (10).

Refer to the instructions supplied with the PT-01 charger. The batteries should typically be fully charged within 4 to 5 hours.

Note: When the external battery charger is plugged in, the PrimeTest 350 will automatically be switched off. It is not possible to use the instrument while the batteries are being charged.

17.5 Battery Replacement

Over a period of time, (typically 1 to 2 years), the batteries will lose their ability to hold charge. (E.g. Even when fully charged, they go flat very quickly when you start using the tester). In this case you will need to replace the batteries, using the procedure described here.



Warning: Always ensure that the PrimeTest 350 is disconnected from all voltage sources before maintenance work is carried out.

- Power the unit off using the red OFF button, ref fig. 1 (3)
- Disconnect the black test lead from the unit
- Disconnect the Seaward mains cable, from the mains inlet socket, ref fig. 2 (7).
- Disconnect the IEC mains cable, from the IEC socket ref fig 2 (8).
- Disconnect the EUT mains cable, from the EUT socket, ref fig. 1 (6).
- Position the PrimeTest 350 face down and release the captive screw in the battery compartment cover.
- Remove the battery compartment cover.
- Remove the old batteries from the compartment.
- Insert the new set of batteries into the battery compartment ensuring that the battery polarity matches the marking on the inside of the battery compartment.
- Relocate the battery cover over the battery compartment and fasten in position with the battery cover captive screw.



This unit will contain Nickel Metal Hydride (NiMH) batteries. Do not dispose of these batteries with other solid waste. Used batteries should be disposed of by a qualified recycler or hazardous materials handler.

17.6 Replacing All Fuses.

If, during one of the powered tests, a message appears stating that incoming mains is missing it is possible that one of the fuses has blown. All fuses should be checked and replaced where necessary.

There are 3 fuses, one in the mains plug and 2 internal fuses. The mains plug fuse is replaced in the same way any plug top fuse is replaced. The internal fuses should be replaced as follows:



Warning: Always ensure that the PrimeTest 350 is disconnected from all voltage sources before maintenance work is carried out.



Attention: Replacement fuses must be in accordance with the specified type, rating and size as stated on the battery compartment cover on the rear of the PrimeTest 350.

Power the unit off using the red OFF button, ref fig. 1 (3).

Disconnect the black test lead from the unit.

Disconnect the Seaward mains cable, from the mains inlet socket, ref fig. 2 (7).

Disconnect the IEC mains cable, from the IEC socket ref fig 2 (8).

Disconnect the EUT mains cable, from the EUT socket, ref fig. 1 (6).

Position the PrimeTest 350 face down and release the captive screw in the battery compartment cover.

Remove the battery compartment cover.

Lift one end of the fuse out of the fuse holder with the help of a flat bladed screwdriver.

Lift the defective fuse completely out of the fuse holder.

Insert a new fuse as described and specified by the text on the battery compartment cover.

Ensure that the new fuse is seated and centred in the fuse holder.

Relocate the battery cover over the battery compartment and fasten in position with the battery cover captive screw.

17.7 Service and Calibration.

To maintain the specified accuracy of the measurement results, the instrument must be recalibrated at regular intervals by either the manufacturer or an **authorised Seaward Service Agent**. We recommend a recalibration period of one year.

If a period of greater than 1 year has elapsed since the last calibration/validation a warning message will appear on the display every time the unit is powered up.

In order to help speed up any service / support request please have all the information from the “About” screen available when you call.

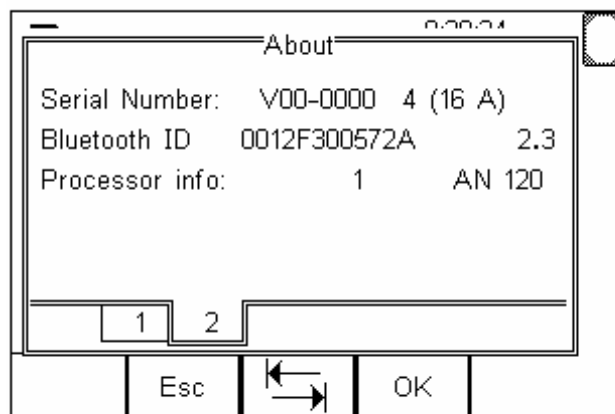
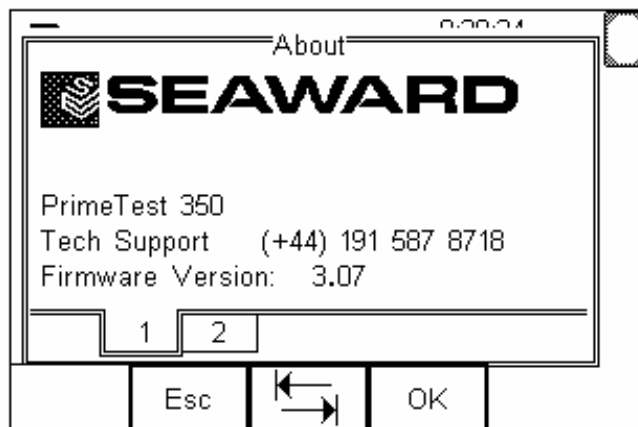

Spare Parts.

	Seaward Part No
Fuse 250V 16A 5x20mm Type T	27B114
Test Lead right-angle heavy duty	44B154
Carry Case	270A951
RS-232 to PC adapter cable	356A004
PT-01 Battery charger	356A003

For Technical Support contact:
Tel: (+44) 191 587 8718

For help or advice on Service and Calibration contact:

Service Department
Seaward Electronic
Bracken Hill
South West Industrial Estate
Peterlee
Co Durham SR8 2SW
England

Tel: (+44) 191 5878739
(+44) 191 5878737
Email: service@seaward.co.uk

18 Useful Information

Parameter	Default	Min	Max
Earth Continuity P/F limit	0.10	0.01	5.0
Earth Continuity Duration	5	2	30
Insulation Resistance P/F limit	1	0.01	10
Insulation Resistance Duration	5	2	30
Substitute Leakage P/F limit	7.0	0.25	15.0
Substitute Leakage Duration	5	2	30
IEC Cord Earth Continuity P/F limit	0.10	0.01	5.0
IEC Cord Insulation P/F limit	1	0.1	10
Touch Current P/F limit	0.25	0.25	5.0
Touch Current Duration	5	2	30
PE Conductor Current P/F limit	0.75	0.25	9.9
PE Conductor Current Duration	5	2	30
Number of tests in a test sequence			30
Characters in a test sequence name			29
Characters in a User Test name			15
Characters in a User Test Unit			15
Total number of Test Sequences			50
Test Results Memory			3Mb
Test Results (typical)			8500
Sites			40
Characters in Site name			15
Locations			70
Characters in Location name			15
Users			40
Characters in User name			15
Comments List			80
Characters in Comment			24